



concept 2[®]

INDOOR ROWERS | SKIERG | BIKEERG



Concept2: A Legacy of Sport

For over forty years, Concept2 has been designing and manufacturing innovative, high-quality products to help you achieve your fitness goals—for better health, training for the Olympics or anything in between.

Regardless of what training machine you choose, you can expect superior products from one of the most well-established companies in fitness. The Performance Monitor 5 (PM5) helps set our machines apart, reliably measuring your power and personal improvements, and allowing for fair comparisons with users anywhere in the world.

All of our products are manufactured in Vermont and ship factory direct. They are built to last, offering commercial-grade quality and durability. Ask about our warranty and 30-day money-back guarantee.

Learn more at concept2.com or give us a call. We're here to help!

INNOVATIVE, HIGH-PERFORMANCE TRAINING EQUIPMENT SINCE 1976

Concept2 Products



ROWERS

Model D

The world's most popular rowing machine, found in homes, health clubs and schools around the world.

Model E

Includes all the proven features of the Model D plus additional height and ruggedness.

Dynamic

The Dynamic is designed to meet specific training needs of the competitive on water athlete.



SkiErg

The SkiErg helps build strength and endurance using the poling motions integral to both techniques of Nordic skiing.



BikeErg

The BikeErg is the latest addition to our family of sport-based ergometers, bringing to cycling our flywheel technology and powerful Performance Monitor.

RowErg

MODEL D

The dependable performance of the Model D has made it our best selling machine. Recognized by athletes as the standard for indoor rowing, the Model D is a solid piece of exercise equipment offered at a great value.

Available in black (shown) and light gray.



Aluminum rail capped with a stainless-steel track allows the seat to move smoothly and facilitates full leg involvement in the rowing stroke

Frame lock enables easy separation for transport and storage

Ergonomic handle allows for natural arm and hand positions

Low-maintenance, nickel-plated chain

PM5 Performance Monitor

Adjustable monitor arm

Spiral damper controls airflow to the flywheel, allowing users to choose the feel of the stroke

Caster wheels make it mobile

Flexfoot™ footrests adjust for quick and easy sizing



Separates easily into two parts for storage.

Length	Width	Seat Height	Weight	Space Recommended For Use	Stored Dimensions	Weight Capacity
96 in 244 cm	24 in 61 cm	14 in 36 cm	57 lb 26 kg	9 ft x 4 ft 274 cm x 122 cm	25 in x 33 in x 54 in H 63.5 cm x 83.8 cm x 137.2 cm H	500 lb 227 kg

RowErg

MODEL E

The Model E offers presence and durability with its 20 inch frame height and powder coat with glossy finish. From a practical standpoint, the higher frame means easier on-and-off for those with tired knees or mobility considerations. One-piece leg design for both the front and rear legs results in stability and a sure, solid feel. A fully enclosed chain housing keeps the nickel-plated chain clean.

The Model E includes all the proven features of the Model D plus those listed here.

Available in light gray (shown) and black.

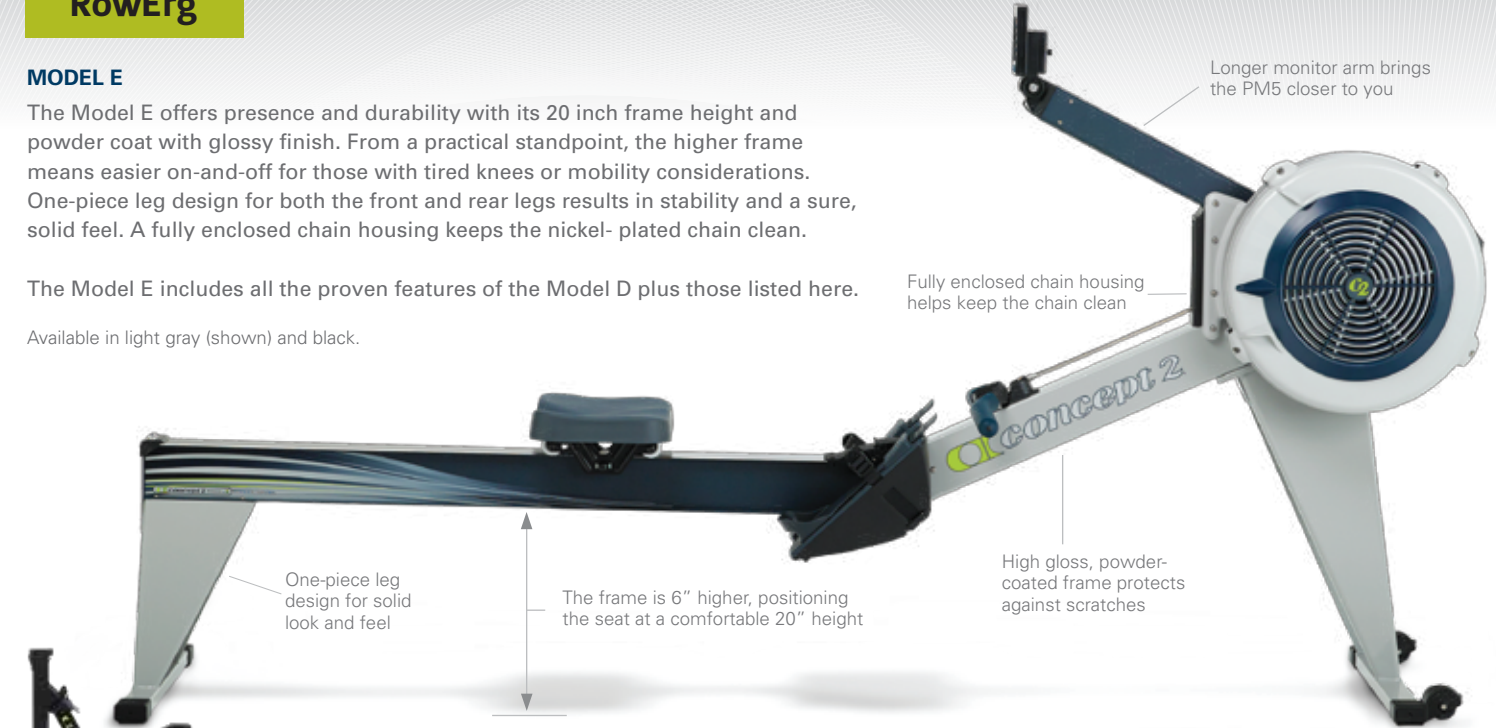

Separates easily into two parts for storage.

Length	Width	Seat Height	Weight	Space Recommended For Use	Stored Dimensions	Weight Capacity
96 in 244 cm	24 in 61 cm	20 in 51 cm	65 lb 29 kg	9 ft x 4 ft 274 cm x 122 cm	27 in x 47 in x 54 in H 68.6 cm x 119.4 cm x 137.2 cm H	500 lb 227 kg

RowErg

DYNAMIC

The Dynamic offers an even closer simulation to rowing on the water. Unlike the Model D and E Indoor Rowers, the footrest on the Dynamic moves, while the feet (and your body mass) move very little throughout the stroke. The Dynamic demands similar concentration and body control to that needed when rowing in a boat, making it an excellent sport-specific training and coaching tool for the competitive rowing athlete.



Length	Width	Seat Height	Weight	Space Recommended For Use	Stored Dimensions	Weight Capacity
76 in 193 cm	24.3 in 62 cm	21.5 in 55 cm	92 lb 42 kg	7.5 ft x 4 ft 229 cm x 122 cm	76 in x 24.3 in x 21.5 in H 193 cm x 62 cm x 55 cm H	500 lb 227 kg

SkiErg

The SkiErg helps build strength and endurance using the poling motions integral to the sport of Nordic skiing, but you don't need to be a skier to benefit from the terrific low impact and full-body exercise. The double poling movement involves not just arms and shoulders, but also core and legs; classic ski technique (alternating arms) is also possible.

The SkiErg easily accommodates adaptive athletes and those with lower body injuries, as one can sit or kneel and still get a great upper body and core workout. The SkiErg is suitable for use with most wheelchairs.



Wall mounted

Wall mount dimensions:

Width	Depth	Height
20.5 in 52 cm	16 in 40.6 cm	83.5 in 212 cm

Floor Stand dimensions (including SkiErg):

Width	Depth	Height
23.5 in 60 cm	50 in 127 cm	85 in 216 cm



Ergonomic strapless handle

Lightweight, high-strength drive cords for smooth feel and long life.

PM5 Performance Monitor

Aluminum frame with powder coat finish makes it light and durable.

Internal drive mechanism allows for both double-pole and classic (alternating arms) technique. Minimal maintenance required.

Optional floor stand with anti-skid, wear-resistant base offers firm footing. Wood interior.

Caster wheels make it mobile (floor stand only).

BikeErg

The BikeErg is the latest addition to our family of sport-based ergometers. The BikeErg uses our air resistance flywheel to create a smooth, quiet ride that responds to your efforts. The damper is your “gearing,” allowing you to adjust the feel of your ride. The BikeErg has a clutch, so when you stop pedaling the flywheel keeps on spinning. With the same powerful Performance Monitor 5 (PM5) as our indoor rowers and SkiErg, the BikeErg provides instantaneous workout feedback, with a wide variety of displays and workouts to choose from.



Length	Width	Seat Height	Weight	Space Recommended For Use	Stored Dimensions	Weight Capacity
48 in 122 cm	24 in 61 cm	31-40.5 in 79-103 cm	58 lb 26 kg	48 in x 24 in 122 cm x 61 cm	Must be stored fully assembled	300 lb 136 kg

Performance Monitor

Display Options



All Data

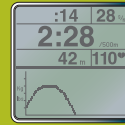

Force Curve



Pacer



Bar Chart



Large Print

PM5 (included on all machines)



Automatic Operation Monitor turns on when you start your workout.

Performance Data Track distance, speed, pace, calories, and watts.

User-Friendly Menu Manage a wide range of features such as preset workouts, games, and multiple languages.

Display Options View all data, force curve, PaceBoat/PaceSkier/PaceBike, bar chart, or large print.

Backlit Display Screen illuminates automatically when you start your workout.

USB Flash Drive Store performance data and transfer data to your Mac or PC.

Wireless Heart Rate Monitoring using ANT+ and Bluetooth with compatible devices.

Connectivity Supports machine-to-machine racing, plus connectivity to computers and smartphones.



Bluetooth®



Go High Tech

Each Concept2 machine comes with everything you need to get fit and stay fit—including our powerful Performance Monitor. If you'd like to access additional data or add entertainment, there are a number of options to consider.

Concept2's free **ErgData** app provides additional performance statistics, stores and displays your workout results, and uploads your results to the Concept2 Online Logbook. Designed to run on iOS and Android devices connected to a Performance Monitor, ErgData:

- connects wirelessly via Bluetooth to the PM5.
- can display additional workout data in real time.
- logs all your results, including intervals, splits and heart rate information.

See concept2.com/ergdata for more details.

A number of apps have also been developed by other companies for use with the Concept2 Performance Monitor. See the latest options available at concept2.com/apps.

(Smartphone Cradle sold separately.)



Join the Online Community

Visit concept2.com to join the online community.



The Online Logbook

Our free online logbook allows you to keep track of all your workouts. It also enables you to participate in our challenges and competitive opportunities.



Online Challenges

Our online challenges offer motivation to exercise just a bit more than you might already! From individual events like the Holiday Challenge to team events like the World Erg Challenge, challenges can help to bring out your best, reinforcing your persistence and self-discipline.



Million Meter Clubs

Our Million Meter Clubs reward perseverance and long-term goals. They start at one million meters and run all the way up to 100 million, so there's always a new target. We recognize your achievement, no matter how long it takes you to get there.



The Online Ranking

For the competitive among us, the Online Ranking lets you compare your performances with athletes from around the world over a number of different events and categories. Our Rankings include everybody from Olympic gold medalists to athletes in their 90s!



Workout of the Day (WOD)

Each day we offer three workouts to help you stay on track with your training. Choose from the short, medium, or long workout depending on your goals and schedule for that day. Sign up on our website to receive your WOD email!

A Legacy Born on Water

Concept2 was founded in 1976 by brothers Dick and Peter Dreissigacker—two engineers with a passion for the sport of rowing. Over the past 40 years, the brothers have applied their experience and engineering to design, manufacture, sell and service unique products for the benefit of the entire Concept2 community. As athletes with high expectations, they're not only inventors but constantly test their products during daily workouts and training sessions.

We continue to promote and encourage the growth of these sports, indoors and outdoors.

Also from Concept2

DREISSIGACKER RACING OARS

Every oar is custom made to your specifications.

ACCESSORIES

We have everything to make indoor training comfortable and easy, from seat pads and floor mats to stylish clothing.

SPARE PARTS

We continue to sell replacement and spare parts as far back as our original Model A Indoor Rower. We will keep your flywheel spinning!

The Concept2 logo features a stylized 'C' icon followed by the text 'concept 2' in a lowercase, italicized sans-serif font, with a registered trademark symbol (®) to the right.

concept2.com 800.245.5676



Concept2 Inc. Pricing as of January 1, 2019

Part Number:	Concept2 Product:	MSRP:
2711	Model D Indoor Rower with PM5 (light gray)	\$900
2712	Model D Indoor Rower with PM5 (black)	\$900
2713	Model E Indoor Rower with PM5 (light gray only)	\$1100
2716	Model E Indoor Rower with PM5 (black)	\$1100
2715	Concept2 SkiErg with PM5 (black only)	\$770
2720	SkiErg Floor Stand	\$180
2900	BikeErg	\$990



DYNAMIC[®]

FITNESS & STRENGTH

STRENGTH CATALOG

ULTRA PRO SERIES



4x3

7 GAUGE STEEL FRAME
+ HEAVY CHROME WRAP

 LEARN MORE AT: MyDynamicFitness.com/UltraPro



ULTRA PRO STANDARD FEATURES

- 1 CHROME UPRIGHT WRAPS w/ 2" ADJUSTMENTS + LASER CUT DYNAMIC LOGO
- 2 NOTCH-LOCK™ J-CUPS & SAFETY ARMS
- 3 12 LONG PLATE STORAGE PEGS
- 4 DUAL LOWER ATTACHMENT RECEPTACLES
- 5 QUAD BAR STORAGE
- 6 VARIABLE GRIP CHIN BAR & BALL GRIPS

*OPTIONAL FEATURES SHOWN (NOT INCLUDED / SOLD SEPARATELY)

CUSTOM RACK LOGOS
REMOVABLE BAND PEGS
FOLD-UP SPOTTER STEPS
CUSTOM COLOR SCHEME

COMPETITION PLATES W/ LOGOS
BARS & COLLARS
ADJUSTABLE BENCH W/ LOGO
PLATFORM INSERT W/ LOGO

PROUDLY DESIGNED AND MANUFACTURED BY



ULTRA PRO ADJUSTABLE
STAND-UP BENCH
709060SU-21*

EDGE POWER RACK 6'X8'
PLATFORM INSERT W/LOGO
EDGEPR-683-PI-LOGO-99*

ULTRA PRO POWER RACK

704004-99*

EDGE SERIES 4x3 7 GAUGE STEEL FRAME

 LEARN MORE AT: MyDynamicFitness.com/Edge

EDGE STANDARD FEATURES

- 1 7 GA. STEEL UPRIGHTS w/ 3.5" ADJUSTMENTS
- 2 NOTCH-LOCK™ J-CUPS & SAFETY ARMS
- 3 12 SHORT PLATE STORAGE PEGS
- 4 DUAL BAR STORAGE
- 5 VARIABLE GRIP CHIN BAR

*OPTIONAL FEATURES SHOWN (NOT INCLUDED / SOLD SEPARATELY)

BAND PEGS & RECEPTACLES
FOLD-UP SPOTTER STEPS
ADJUSTABLE BENCH W/ LOGO

COMPETITION PLATES W/ LOGOS
BARS & COLLARS
BELTS, BANDS, ROPES

PROUDLY DESIGNED AND MANUFACTURED BY



ANNEX STORAGE
BOLTS IN
BETWEEN 2 RACKS



EDGE ADJUSTABLE
POP PIN BENCH
509060SU-04*

EDGE HALF RACK
500012H-04-T*

EDGE HALF RACK 4'X8'
PLATFORM INSERT W/LOGO
EDGEHR-483-PI-LOGO-99*

ULTRA PRO HALF RACK

704003-99*

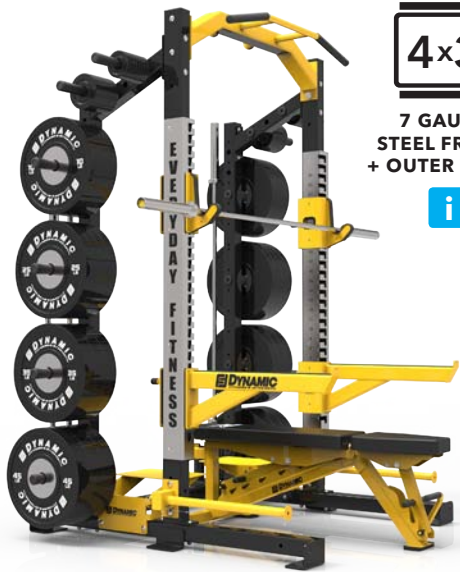

4x3

7 GAUGE
STEEL FRAME
+ OUTER WRAP



ULTRA PRO DOUBLE HALF RACK DP

704005-99*



ULTRA PRO POWER/HALF RACK DP

704017-99*



ULTRA PRO / EDGE RACK ATTACHMENTS

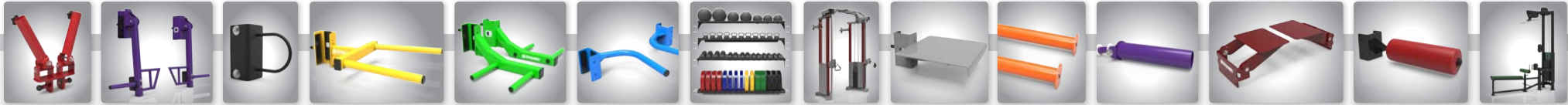

709040-04-T 709020-19-T 509021-01-T 709009-12-T 709046-99* 709032-99 ANNEX STORAGE 701011-99* 709034-02-T 709010-14-T 709007-19-T 709002-23-T 709031-01-T* 709047-01*

PROUDLY DESIGNED AND MANUFACTURED BY



**ANNEX STORAGE
BOLTS IN
BETWEEN 2 RACKS**



EDGE 3/4 RACK 500013H-99*



EDGE POWER RACK 9' 500015H-99*

4x3

7 GAUGE
STEEL FRAME



EDGE DOUBLE HALF RACK SP 500016SP-99*

TITAN



SERIES

3x3 11 GAUGE STEEL FRAME



SEE MORE AT: MyDynamicFitness.com/Titan



TITAN DOUBLE HALF RACK SP
400016-99*



TITAN POWER RACK W/ STORAGE
400015-99*



TITAN RIG STYLE POWER RACK
400001-23-T*



TITAN HALF RACK W/ XSTORAGE
400012-99*

*SOME RACKS SHOWN WITH CUSTOM COLORS OR LOGO UPGRADES, AND/OR WITH OPTIONAL ATTACHMENTS OR ACCESSORIES, SOLD SEPARATELY.



SEE MORE AT: MyDynamicFitness.com/Gladiator

GLADIATOR



SERIES

2x3 11 GAUGE STEEL FRAME



GLADIATOR POWER RACK
300005-99*



GLADIATOR DOUBLE HALF RACK SP
300016-99*



GLADIATOR HALF/HALF COMBO + ANNEX
300052-03-T*

BENCHES & GHD



**ULTRA PRO
LADDER BENCH SP**
709060SP-14*



**ACCELL LADDER
BENCH SU**
109060SU-11*



**ULTRA PRO
WALK THRU GHD**
709072-99*



**ICONIC
INVERSE
CURL®**
700018-99*

**ICONIC 5 DEGREE
REVERSE
HYPER®**
700017-99*

SEE MORE AT: MyDynamicFitness.com/Benches

SPECIALIZED



CABLE CROSSOVER TRAINER
701003-99*

EDGE VKR
509072-99*



**HEAD
& NECK
ISOLATOR™**
700030-99*



**ULTRA PRO
45 DEGREE
LEG PRESS**
702001-99*



EDGE 45 DEGREE HYPER
509074-23



**G-MAX™
GLUTE BRIDGE**
701370-99*

SEE MORE AT: MyDynamicFitness.com/Specialized

SLEDS

**ACCELL POWER SLED
W/ HARD SURFACE FEET**
109991-21*



109996-14*



109992-99*



109998-19*

SEE MORE AT: MyDynamicFitness.com/Sleds

STORAGE

509080-99*



509083-14*



400020-12*



509085-99*

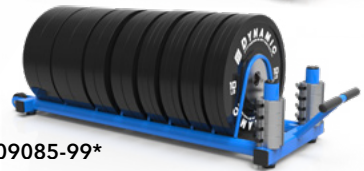

SEE MORE AT: MyDynamicFitness.com/Storage

*SOME ITEMS SHOWN WITH CUSTOM COLORS OR LOGO UPGRADES, AND/OR WITH OPTIONAL FEATURES OR ACCESSORIES, SOLD SEPARATELY.

PLATFORMS

6'x8'
PLTSAT-683-11*



PLTSASD-483-LOGO-12
4'x8'

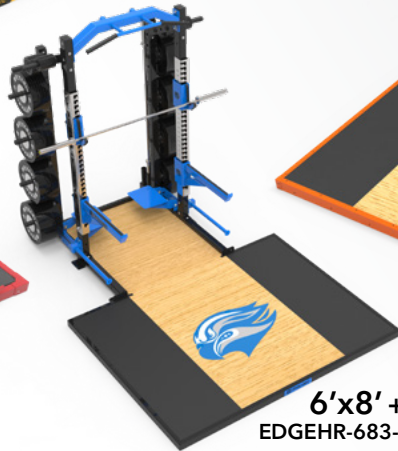

PLTSAT-483-04*
4'x8'



PLTSA-683-LOGO-14
6'x8'

6'x8' + INSERT
EDGEHR-683-PI-LOGO-01*

SEE MORE AT: MyDynamicFitness.com/Platforms

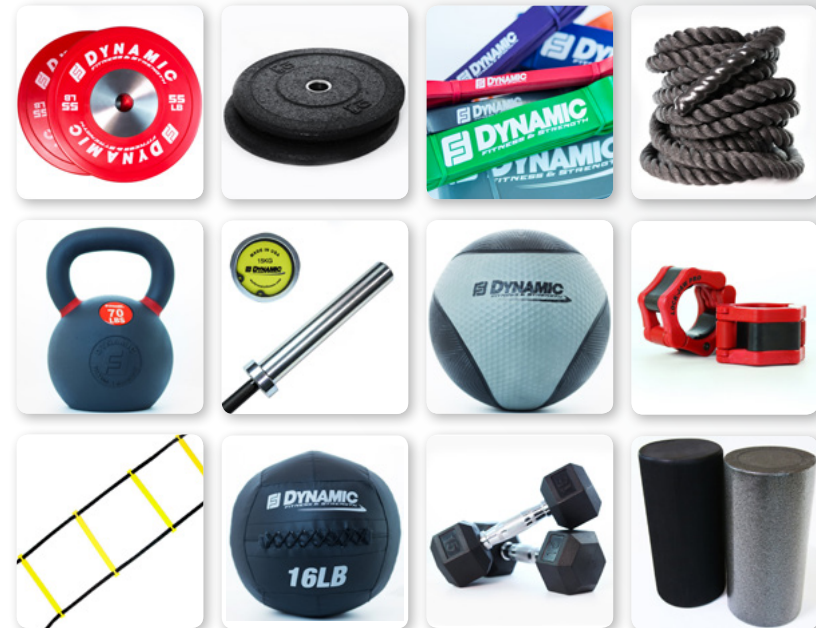

SHOP NOW AT: MyDynamicFitness.com/Accessories

DESIGN, CUSTOMIZE, PERSONALIZE.

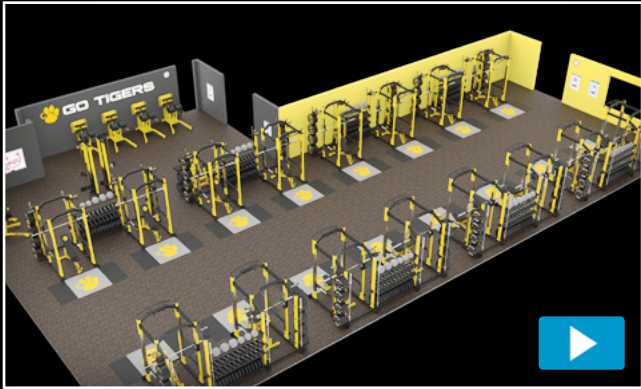

BRANDED BENCH PADS



BRANDED PLATES



BRANDED CONNECTORS



BRANDED RACKS



BRANDED PLATFORMS



BRANDED BARS



LEARN MORE AT: [MyDynamicFitness.com/Customize](https://www.MyDynamicFitness.com/Customize)



#DYNAMICATHLETE



www.MyDynamicFitness.com



Call for Weight Room Design

844-678-7447

SB16-080818



FUNCTIONAL TRAINING RIGS

2017 RIGS CATALOG

Incorporating a functional training space is essential for facilities. With Olympic lifting, body weight movement, calisthenics group classes, and personal training, you are investing in your members and trainers. Now you can retain your existing members with a new fitness medium while attracting first-time members with popular dynamic training options. Dynamic Functional Training Rigs offer a variety of designs to fit your facility and member needs.

v21 011817 np



4' PERSONAL MONKEY BAR RIG

Designed for your facility's strength floor, our 4' Personal Monkey Bar Rig creates a variety of training opportunities. Members can enjoy individual training with monkey bars, dip station, squat rack, suspension trainer and landmine. Add Olympic bars and plates to attract your hardcore members. Convenient plate storage pegs keep the unit safe and clutter-free. Supports 4-5 people simultaneously.



**Suspension trainers are optional as shown, and not included in price.*

T-4CR003

STANDARD FEATURES

FRAME

- (4) 9' UPRIGHTS
- (2) XD SINGLE BARS 4'
- (3) SINGLE MONKEY BARS 4'
- (2) SINGLE BARS 4'
- (4) HEX ANCHOR BOLT KITS (4 ea.)

- 11 Ga 3"x3" Tubular Steel Frame
- 1" Grade 5 Hardware
- Dimensions: 7' L x 4' D x 9' H
- Floor Area: 16' L x 6' D

ATTACHMENTS

- (1) PAIR TAKE OFF J-CUPS
- (1) PAIR SAFETY ARMS
- (1) DIP STATION
- (1) LANDMINE
- (2) SINGLE BAR FRAME STORAGE
- (6) PLATE STORAGE PEGS

T-4CR003-A

ACCESSORY UPGRADE PACKAGE

ACCESSORIES

- (2) DYNAMIC MEN'S OLYMPIC BARS
- (1) PAIR SPRING COLLARS
- (8) 45 LB BUMPER PLATES
- (8) 25 LB BUMPER PLATES
- (8) 10 LB BUMPER PLATES

6' MONKEY BAR RIG

Designed for your facility's strength floor, our 6' Monkey Bar Rig offers a variety of training stations. Members can enjoy individual training with monkey bars, dip station, landmine, ball target, plyo step, optional Olympic bar and plates, suspension trainer, heavy bag and battle rope. The simple, clean storage area keeps your facility looking its best. Supports 6-8 people simultaneously.

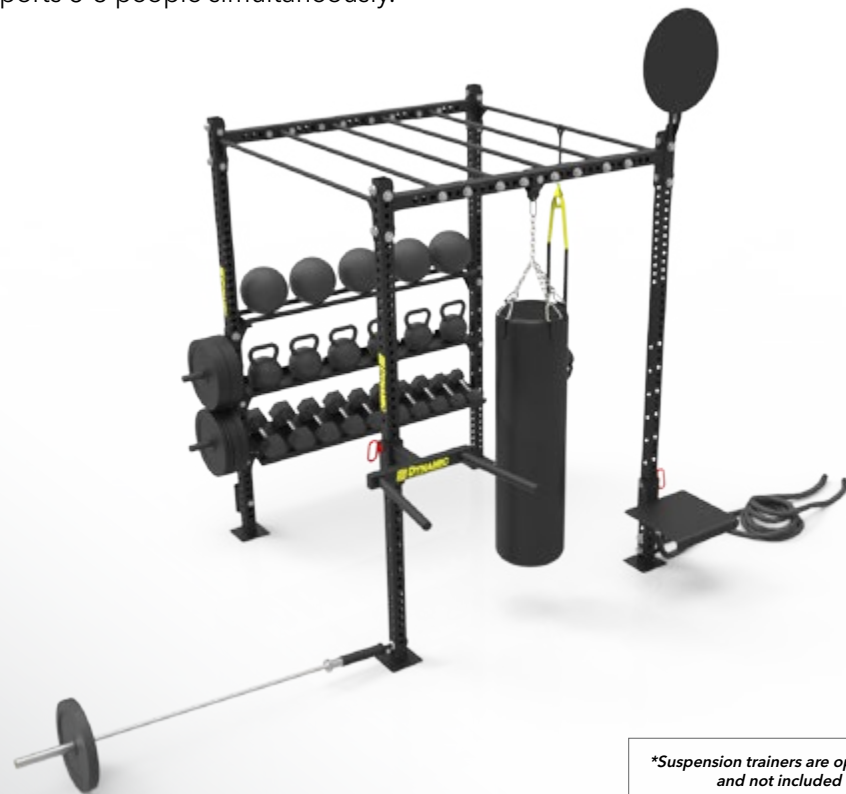

**Suspension trainers are optional as shown, and not included in price.*

T-6CR001

STANDARD FEATURES

FRAME

- (4) UPRIGHTS 9'
- (2) SINGLE BARS 6'
- (2) XD SINGLE BARS 6'
- (4) SINGLE MONKEY BARS 6'
- (4) HEX ANCHOR BOLT KITS (4 EA.)
- 11 Ga 3"x3" Tubular Steel Frame
- 1" Grade 5 Hardware
- Dimensions: 7' L x 8' D x 11'3" H
- Floor Area: 30' L x 8' D

ATTACHMENTS

- (1) DIP STATION
- (1) LANDMINE
- (1) 22" BALL TARGET W/LOGO
- (1) D-HANDLE
- (1) PLYO STEP
- (1) SINGLE BAR FRAME STORAGE
- (1) DUMBBELL STORAGE TRAY
- (1) KETTLE BELL STORAGE TRAY
- (1) BALL STORAGE TRAY
- (1) SHACKLE W/ CARABINER
- (2) PLATE STORAGE PEGS

T-6CR001-A

ACCESSORY UPGRADE PACKAGE

ACCESSORIES

- (1) DYNAMIC MEN'S OLYMPIC BAR
- (2) 45 LB BUMPER PLATES
- (2) 25 LB BUMPER PLATES
- (2) 10 LB BUMPER PLATES
- (1) 9 LB KETTLE BELL
- (1) 13 LB KETTLE BELL
- (1) 18 LB KETTLE BELL
- (1) 26 LB KETTLE BELL
- (1) 35 LB KETTLE BELL
- (1) 44 LB KETTLE BELL
- (1) 30' X 1.5" BATTLE ROPE
- (1) 6 LB WALL BALL
- (1) 10 LB WALL BALL
- (1) 14 LB WALL BALL
- (1) 18 LB WALL BALL
- (1) 25 LB WALL BALL
- (2) 5 LB HEX DUMBBELL
- (2) 10 LB HEX DUMBBELL
- (2) 15 LB HEX DUMBBELL
- (2) 20 LB HEX DUMBBELL
- (2) 25 LB HEX DUMBBELL
- (2) 30 LB HEX DUMBBELL
- (2) 35 LB HEX DUMBBELL
- (1) HEAVY BAG

14' MONKEY BAR RIG

Build excitement in your facility when you develop functional training group classes using the 14' Monkey Bar Rig. Your members will go crazy over the variety of movements possible! Support 8-10 people simultaneously with dip station, squat rack, monkey bars, landmine, ball target, plyo step, battle rope, chin-up bar, pull-up bar, optional Olympic bars and plates, suspension trainers and so much more. Optional rolling plate storage keeps the area safe and clutter-free.



**Suspension trainers are optional as shown, and not included in price.*

T-14CR002

STANDARD FEATURES

FRAME

- (8) 9' UPRIGHTS
- (4) SINGLE BARS 6'
- (2) XD DOUBLES 6'
- (4) XD DOUBLE BARS 4'
- (11) SINGLE MONKEY BARS 6'
- (8) HEX ANCHOR BOLT KITS (4 EA.)
- 11 Ga 3"x3" Tubular Steel Frame
- 1" Grade 5 Hardware
- Dimensions: 16' L x 8' D x 11'3"H
- Floor Area: 16' L x 24' D

ATTACHMENTS

- (2) PAIR TAKE OFF J-CUPS
- (2) PAIR SAFETY ARMS
- (1) DIP STATION
- (1) LANDMINE
- (1) 22" BALL TARGET W/ LOGO
- (1) D-HANDLE
- (1) PLYO STEP
- (1) SINGLE BAR FRAME STORAGE

T-14CR002-A

ACCESSORY UPGRADE PACKAGE

ACCESSORIES

- (3) DYNAMIC MEN'S OLYMPIC BARS
- (4) SPRING COLLARS
- (8) 45LB BUMPER PLATES
- (6) 25LB BUMPER PLATES
- (6) 10LB BUMPER PLATES
- (1) 30' X 1.5" BATTLE ROPE
- (2) ROLLING PLATE STORAGE

20' INCLINE MONKEY BAR RIG

Train up to 18 people at the same time with the large 20' Monkey Bar Rig. Our limitless fitness, strength, and cross-functional stations keep your members coming back for more. Design your facility's space to fit your needs with the dip station, squat racks, monkey bar bridges, landmines, ball target, plyo steps, battle ropes, glute/ham developer, optional Olympic bars and plates, suspension trainers, and so much more! And the impressive storage area keeps your facility clean, safe, and clutter-free. Supports 16-18 people simultaneously.



**Suspension trainers are optional as shown, and not included in price.*

T-20CR002

STANDARD FEATURES

FRAME

- (6) 9' UPRIGHTS
- (4) 12' UPRIGHTS
- (5) SINGLE BARS 6'
- (4) XD DOUBLE BARS 6'
- (1) DOUBLE BAR 6'
- (18) SINGLE MONKEY BARS 6'
- (4) XD INCLINES 4'
- (10) HEX ANCHOR BOLT KITS (4 EA.)
- (4) SINGLE PULL UP BARS 4'
- 11 Ga 3"x3" Tubular Steel Frame
- 1" Grade 5 Hardware
- Dimensions: 24' L x 10' D x 12' H
- Floor Area: 38' L x 10' D

ATTACHMENTS

- (1) DIP STATION
- (1) LANDMINE
- (1) 22" BALL TARGET W/ LOGO
- (2) PAIR TAKE OFF J-CUPS
- (2) D-HANDLE
- (2) PAIRS SAFETY ARMS
- (2) PLYO STEPS
- (1) DUMBBELL STORAGE TRAY
- (1) KETTLE BELL STORAGE TRAY
- (1) BALL STORAGE TRAY
- (1) PLATE STORAGE TRAY
- (1) SINGLE PAD GLUTE HAM
- (1) SINGLE BAR FRAME STORAGE

T-20CR002-A

ACCESSORY UPGRADE PACKAGE

ACCESSORIES

- (3) DYNAMIC MEN'S OLYMPIC BARS
- (2) PAIRS SPRING COLLARS
- (6) 45 LB BUMPER PLATES
- (4) 25 LB BUMPER PLATES
- (4) 10 LB BUMPER PLATES
- (1) 9 LB KETTLE BELL
- (1) 13 LB KETTLE BELL
- (1) 18 LB KETTLE BELL
- (1) 26 LB KETTLE BELL
- (1) 35 LB KETTLE BELL
- (1) 44 LB KETTLE BELL
- (2) 30' X 1.5" BATTLE ROPES
- (1) 6 LB WALL BALL
- (1) 10 LB WALL BALL
- (1) 14 LB WALL BALL
- (1) 18 LB WALL BALL
- (1) 25 LB WALL BALL
- (2) 5 LB HEX DUMBBELL
- (2) 10 LB HEX DUMBBELL
- (2) 15 LB HEX DUMBBELL
- (2) 20 LB HEX DUMBBELL
- (2) 25 LB HEX DUMBBELL
- (2) 30 LB HEX DUMBBELL
- (2) 35 LB HEX DUMBBELL

10' STANDARD RIG

Build excitement in your facility when you develop functional training group classes using the 10' Standard Rig. Your members will go crazy over the variety of movements! Support 8-10 people simultaneously with the dip station, squat rack, landmine, plyo step, battle rope, optional Olympic bar and plates, suspension trainers and so much more. Optional rolling plate storage keeps the area clutter-free.



**Suspension trainers are optional as shown, and not included in price.*

T-CR-10W6D

STANDARD FEATURES

FRAME

- (2) 4' SINGLE BARS
- (2) 6' SINGLE BARS
- (3) 6' DOUBLE BARS
- (6) 9' UPRIGHTS
- (6) HEX ANCHOR BOLT KITS (4 EA.)
- 11 Ga 3"x3" Tubular Steel Frame
- 1" Grade 5 Hardware
- Dimensions: 14' L x 9' D x 9' H
- Floor Area: 34' L x 9' D

ATTACHMENTS

- (1) TAKE OFF J-CUPS
- (1) PAIR SAFETY ARMS
- (1) D-HANDLE
- (1) LANDMINE
- (1) DIP STATION
- (1) PLYO STEP
- (1) SINGLE BAR FRAME STORAGE
- (1) PLATE STORAGE PEG

T-CR-10W6D-A

ACCESSORY UPGRADE PACKAGE

ACCESSORIES

- (2) DYNAMIC MEN'S OLYMPIC BARS
- (1) PAIR SPRING COLLARS
- (8) 45 LB BUMPER PLATES
- (4) 25 LB BUMPER PLATES
- (4) 10 LB BUMPER PLATES
- (1) ROLLING PLATE STORAGE
- (1) 30' X 1.5" BATTLE ROPE

14' STANDARD RIG

Build excitement in your facility when you develop functional training group classes using the 14' Standard Rig. Your members will go crazy over the variety of movements! Support 10-12 people simultaneously with the optional Olympic bars and plates, dip station, squat rack, landmine, plyo step, battle rope, and so much more. Optional rolling plate storage keeps the area safe and clutter-free.



**Suspension trainers are optional as shown, and not included in price.*

T-CR-14W6D

STANDARD FEATURES

FRAME

- (4) 4' SINGLE BARS
- (2) 6' SINGLE BARS
- (4) 6' DOUBLE BARS
- (8) 9' UPRIGHTS
- (8) HEX ANCHOR BOLT KITS (4 EA.)

- 11 Ga 3"x3" Tubular Steel Frame
- 1" Grade 5 Hardware
- Dimensions: 16' L x 10' D x 9' H
- Floor Area: 16' L x 25' D

ATTACHMENTS

- (2) PAIRS TAKE OFF J-CUPS
- (2) PAIRS SAFETY ARMS
- (2) D-HANDLES
- (1) LANDMINE
- (1) DIP STATION
- (1) PLYO STEP
- (1) SINGLE BAR FRAME STORAGE

T-CR-14W6D-A

ACCESSORY UPGRADE PACKAGE

ACCESSORIES

- (3) DYNAMIC MEN'S OLYMPIC BARS
- (2) PAIRS SPRING COLLARS
- (8) 45 LB BUMPER PLATES
- (8) 25 LB BUMPER PLATES
- (8) 10 LB BUMPER PLATES
- (2) 30' X 1.5" BATTLE ROPES
- (2) ROLLING PLATE STORAGE

24' STANDARD RIG

Train up to 16 people at the same time with the large 24' Standard Rig. Our limitless fitness, strength, and cross-functional stations keep your members coming back for more! Design your facility's space to fit your needs with dip stations, squat racks, landmines, plyo steps, battle ropes, optional Olympic bars and plates, suspension trainers and so much more. The optional rolling plate storage keeps your facility safe and clutter-free. Supports 14-16 people simultaneously.



**Suspension trainers are optional as shown, and not included in price.*

T-CR-24W6D

STANDARD FEATURES

FRAME

- (12) 9' UPRIGHTS
- (6) 4' SINGLE BARS
- (4) 6' SINGLE BARS
- (6) 6' DOUBLE BARS
- (12) HEX ANCHOR BOLT KITS (4 EA.)
- 11 Ga 3"x3" Tubular Steel Frame
- 1" Grade 5 Hardware
- Dimensions: 24' L x 10' D x 9' H
- Floor Area: 32' L x 23' D

ATTACHMENTS

- (3) PAIRS TAKE OFF J-CUPS
- (3) PAIRS SAFETY ARMS
- (2) D-HANDLES
- (2) LANDMINES
- (2) DIP STATIONS
- (2) PLYO STEPS
- (2) SINGLE BAR FRAME STORAGE

T-CR-24W6D-A

ACCESSORY UPGRADE PACKAGE

ACCESSORIES

- (5) DYNAMIC MEN'S OLYMPIC BARS
- (3) PAIRS SPRING COLLARS
- (10) 45 LB BUMPER PLATES
- (10) 25 LB BUMPER PLATES
- (10) 10 LB BUMPER PLATES
- (2) 30' X 1.5" BATTLE ROPES
- (3) ROLLING PLATE STORAGE

6' M³ZONE 3.0 RIG

Designed for your facility's strength floor, our 6' M³ ZONE 3.0 Rig comes with a variety of training stations. Members can enjoy individual training with the dip station, landmine, ball target and plyo step. Add the Olympic bar, plates, battle rope, suspension trainer and heavy bag to really attract your hardcore members. The simple, clean storage trays keep your facility clutter-free and looking its best. Supports 6-8 people simultaneously.



**Suspension trainers are optional as shown, and not included in price.*

T-M3ZONE3.0

STANDARD FEATURES

FRAME

- (6) 8'4" UPRIGHTS
- (2) 6' TRI BARS
- (4) XD SINGLE 20" EXTENDERS
- (1) SINGLE BAR 6'
- (6) HEX ANCHOR BOLT KITS (4 EA.)
- 11 Ga 3"x3" Tubular Steel Frame
- 1" Grade 5 Hardware
- Dimensions: 11' L x 6' D x 11' 3"H
- Floor Area: 11' L x 25' D

ATTACHMENTS

- (1) 22" BALL TARGET W/LOGO
- (1) DIP STATION
- (1) LANDMINE
- (1) D-HANDLE
- (1) PLYO STEP
- (1) CANTILEVER ARM W/ SHACKLE
- (1) DUMBBELL STORAGE TRAY
- (1) KETTLE BELL STORAGE TRAY
- (1) BALL STORAGE TRAY
- (2) PLATE STORAGE PEGS
- (1) SINGLE BAR FRAME STORAGE

T-M3ZONE3.0-A

ACCESSORY UPGRADE PACKAGE

ACCESSORIES

- (1) DYNAMIC MEN'S OLYMPIC BAR
- (2) 45 LB BUMPER PLATES
- (2) 25 LB BUMPER PLATES
- (2) 10 LB BUMPER PLATES
- (1) 9 LB KETTLE BELL
- (1) 13 LB KETTLE BELL
- (1) 18 LB KETTLE BELL
- (1) 26 LB KETTLE BELL
- (1) 35 LB KETTLE BELL
- (1) 44 LB KETTLE BELL
- (1) 30' X 1.5" BATTLE ROPE
- (1) 6 LB WALL BALL
- (1) 10 LB WALL BALL
- (1) 14 LB WALL BALL
- (1) 18 LB WALL BALL
- (1) 25 LB WALL BALL
- (2) 5 LB HEX DUMBBELL
- (2) 10 LB HEX DUMBBELL
- (2) 15 LB HEX DUMBBELL
- (2) 20 LB HEX DUMBBELL
- (2) 25 LB HEX DUMBBELL
- (2) 30 LB HEX DUMBBELL
- (2) 35 LB HEX DUMBBELL
- (1) HEAVY BAG

12' M³ZONE 4.0 RIG

Build excitement in your facility when you develop functional training group classes using the 12' M³ ZONE 4.0 Rig. Your members will go crazy over the variety of movements! Support 10-12 people simultaneously with the dip station, squat rack, monkey bars, landmine, ball target, plyo step, pull-up bar, flying pull-up extension, optional Olympic bars and plates, battle rope, suspension trainer and so much more. And our creative and safe storage feature keeps your facility uncluttered.



**Suspension trainers are optional as shown, and not included in price.*

T-M3ZONE4.0

STANDARD FEATURES

FRAME

- (12) 8'4" UPRIGHTS
- (6) SINGLE MONKEY BARS 4'
- (5) XD SINGLES 4'
- (2) XD DOUBLES 4'
- (2) SINGLE BARS 4'
- (4) XD SINGLE 20" EXTENDERS
- (12) HEX ANCHOR BOLT KITS (4 EA.)

- 11 Ga 3"x3" Tubular Steel Frame
- 1" Grade 5 Hardware
- Dimensions: 16' L x 12' D x 11'3" H
- Floor Area: 16' L x 26' D

ATTACHMENTS

- (1) CANTILEVER ARM W/SHACKLE
- (1) FLYING PULL UP EXTENSION 4'
- (1) CHIN UP BAR
- (1) PAIR TAKE OFF J-CUPS
- (1) PAIR SAFETY ARMS
- (1) DIP STATION
- (1) 22" BALL TARGET W/LOGO
- (1) PLYO STEP
- (1) LANDMINE
- (1) D-HANDLE
- (2) DUMBBELL STORAGE TRAYS
- (2) KETTLE BELL STORAGE TRAYS
- (2) BALL STORAGE TRAYS
- (2) PLATE STORAGE TRAYS
- (2) SINGLE BAR FRAME STORAGE

T-M3ZONE4.0-A

ACCESSORY UPGRADE PACKAGE

ACCESSORIES

- (2) DYNAMIC MEN'S OLYMPIC BARS
- (1) PAIR SPRING COLLARS
- (8) 45 LB BUMPER PLATES
- (6) 25 LB BUMPER PLATES
- (4) 10 LB BUMPER PLATES
- (1) 9 LB KETTLE BELL
- (1) 13 LB KETTLE BELL
- (1) 18 LB KETTLE BELL
- (1) 26 LB KETTLE BELL
- (1) 35 LB KETTLE BELL
- (1) 44 LB KETTLE BELL
- (1) 30' X 1.5" BATTLE ROPE
- (1) 6 LB WALL BALL
- (1) 10 LB WALL BALL
- (1) 14 LB WALL BALL
- (1) 18 LB WALL BALL
- (2) 5 LB HEX DUMBBELL
- (2) 10 LB HEX DUMBBELL
- (2) 15 LB HEX DUMBBELL
- (2) 20 LB HEX DUMBBELL
- (2) 25 LB HEX DUMBBELL
- (2) 30 LB HEX DUMBBELL
- (2) 35 LB HEX DUMBBELL
- (2) 40 LB HEX DUMBBELL
- (1) HEAVY BAG

14' PREMIUM EXTENSION RIG

Build excitement in your facility when you develop functional training group classes using the 14' Premium Extension Rig. Your members will go crazy over the variety of movements! Support 10-12 people simultaneously with the dip station, squat rack, monkey bars, landmine, ball target, plyo step, optional Olympic bars and plates, battle rope, suspension trainers, and so much more. And our convenient, safe storage trays keep your facility clutter-free.



**Suspension trainers are optional as shown, and not included in price.*

T-14CR0038

STANDARD FEATURES

FRAME

- (12) 9' UPRIGHTS
- (4) SINGLE BAR 4'
- (1) SINGLE BARS 6'
- (2) XD DOUBLES 6'
- (6) XD DOUBLE BARS 4'
- (4) XD SINGLE 2' EXTENDERS
- (11) SINGLE MONKEY BARS 4'
- (12) HEX ANCHOR BOLT KITS (4 EA.)

- 11 Ga 3"x3" Tubular Steel Frame
- 1" Grade 5 Hardware
- Dimensions: 18' L x 10' D x 9' H
- Floor Area: 31' L x 10' D

ATTACHMENTS

- (4) PAIRS TAKE OFF J-CUPS
- (4) PAIRS SAFETY ARMS
- (1) DIP STATION
- (1) LANDMINE
- (1) D-HANDLE
- (1) PLYO STEP
- (1) DUMBBELL STORAGE TRAY
- (1) KETTLE BELL STORAGE TRAY
- (1) BALL STORAGE TRAY
- (1) PLATE STORAGE TRAY
- (1) SINGLE BAR FRAME STORAGE

T-14CR0038-A

ACCESSORY UPGRADE PACKAGE

ACCESSORIES

- (5) DYNAMIC MEN'S OLYMPIC BARS
- (4) PAIRS SPRING COLLARS
- (8) 45 LB BUMPER PLATES
- (6) 25 LB BUMPER PLATES
- (6) 10 LB BUMPER PLATES
- (1) 9 LB KETTLE BELL
- (1) 13 LB KETTLE BELL
- (1) 18 LB KETTLE BELL
- (1) 26 LB KETTLE BELL
- (1) 35 LB KETTLE BELL
- (1) 44 LB KETTLE BELL
- (2) 5 LB HEX DUMBBELL
- (2) 10 LB HEX DUMBBELL
- (2) 15 LB HEX DUMBBELL
- (2) 20 LB HEX DUMBBELL
- (2) 25 LB HEX DUMBBELL
- (2) 30 LB HEX DUMBBELL
- (2) 35 LB HEX DUMBBELL
- (1) 6 LB WALL BALL
- (1) 10 LB WALL BALL
- (1) 14 LB WALL BALL
- (1) 18 LB WALL BALL
- (1) 25 LB WALL BALL
- (1) 30' X 1.5" BATTLE ROPE

14' PREMIUM "X" RIG

Build excitement in your facility when you develop functional training group classes using the 14' Premium "X" Rig. Your members will go crazy over the variety of movements possible! Support 12-14 people simultaneously with dip station, squat rack, monkey bars, landmine, plyo step, optional Olympic bars and plates, suspension trainers, battle rope, and so much more. And our convenient, safe storage trays keep your facility clutter-free.



**Suspension trainers are optional as shown, and not included in price.*

T-14CR007

STANDARD FEATURES

FRAME

- (12) 9' UPRIGHTS
- (2) 4' DOUBLE BARS
- (4) 6' SINGLE BARS
- (3) 4' XD DOUBLE BARS
- (2) 6' XD DOUBLE BARS
- (4) 4' XD SINGLE BARS
- (11) 6' MONKEY BARS
- (1) 4' TRI BAR
- (12) HEX ANCHOR BOLT KITS (4 EA.)
- 11 Ga 3"x3" Tubular Steel Frame
- 1" Grade 5 Hardware
- Dimensions: 15' L x 18' D x 11'3" H
- Floor Area: 15' L x 33' D

ATTACHMENTS

- (1) PAIR TAKE OFF J-CUPS
- (1) PAIR SAFETY ARMS
- (1) DUMBBELL STORAGE TRAY
- (1) KETTLE BELL STORAGE TRAY
- (1) BALL STORAGE TRAY
- (1) PLATE STORAGE TRAY
- (1) D-HANDLE
- (1) LANDMINE
- (1) DIP STATION
- (1) PLYO STEP
- (1) SINGLE PAD GHD
- (1) FLYING PULL UP
- (1) CHIN UP BAR
- (1) 22" BALL TARGET W/LOGO
- (1) SHACKLE W/CARABINER
- (1) SINGLE BAR FRAME STORAGE
- (2) PULL UP BALLS
- (1) PLATE STORAGE PEG

T-14CR007-A

ACCESSORY UPGRADE PACKAGE

ACCESSORIES

- (2) DYNAMIC MEN'S OLYMPIC BARS
- (1) PAIR SPRING COLLARS
- (10) 45 LB BUMPER PLATES
- (4) 25 LB BUMPER PLATES
- (6) 10 LB BUMPER PLATES
- (1) 9 LB KETTLE BELL
- (1) 13 LB KETTLE BELL
- (1) 18 LB KETTLE BELL
- (1) 26 LB KETTLE BELL
- (1) 35 LB KETTLE BELL
- (1) 44 LB KETTLE BELL
- (2) 5 LB HEX DUMBBELLS
- (2) 10 LB HEX DUMBBELLS

- (2) 12.5 LB HEX DUMBBELL
- (2) 15 LB HEX DUMBBELL
- (2) 20 LB HEX DUMBBELL
- (2) 25 LB HEX DUMBBELL
- (2) 30 LB HEX DUMBBELL
- (2) 35 LB HEX DUMBBELL
- (1) 30' X 1.5" BATTLE ROPE
- (1) 6 LB WALL BALL
- (1) 10 LB WALL BALL
- (1) 14 LB WALL BALL
- (1) 18 LB WALL BALL
- (1) 25 LB WALL BALL
- (1) HEAVY BAG

CORNER TRAINING UNIT

Build excitement in your facility when you develop functional training group classes using the Corner Training Unit. Your members will go crazy over the variety of movements possible, and you'll see new revenue come from a previously unused corner! Support 3-5 people simultaneously with the dip station, landmine, ball target, plyo step, chin-up bar, optional Olympic bar and plates, battle rope, suspension trainers and so much more. This creative training unit creates new functional space in your corner areas, while keeping your facility safe and clutter-free.



**Suspension trainers are optional as shown, and not included in price.*

400026

STANDARD FEATURES

FRAME

- (4) 8'4" UPRIGHTS
- (2) XD SINGLES 4'
- (2) XD SINGLE CORNER
- (1) XD SINGLE ANCHOR CORNER
- (1) DOUBLE BAR CORNER XMEMBER
- (4) HEX ANCHOR BOLT KITS (4 EA.)

- 11 Ga 3"x3" Tubular Steel Frame
- 1" Mating Bolts
- Dimensions: 8' L x 8' D x 11'3" H
- Floor Area: 15' L x 8' D

ATTACHMENTS

- (1) DIP STATION
- (1) 22" BALL TARGET W/LOGO
- (1) PLYO STEP
- (1) LANDMINE
- (4) BAND ANCHOR UPRIGHTS
- (2) MINI ATTACHMENTS UPRIGHTS
- (2) BALL STORAGE SHELVES
- (2) KETTLE BELL STORAGE SHELVES
- (2) DUMBBELL STORAGE SHELVES
- (2) ROPE ANCHORS
- (2) SINGLE BAR FRAME STORAGE
- (3) PLATE STORAGE PEGS

400026-A

ACCESSORY UPGRADE PACKAGE

ACCESSORIES

- (1) DYNAMIC MEN'S OLYMPIC BAR
- (1) 9LB KETTLE BELL
- (1) 13LB KETTLE BELL
- (1) 18LB KETTLE BELL
- (1) 26LB KETTLE BELL
- (1) 35LB KETTLE BELL
- (1) 44LB KETTLE BELL
- (1) 30' X 1.5" BATTLE ROPE
- (1) 6LB WALL BALL
- (1) 10LB WALL BALL
- (1) 14LB WALL BALL
- (1) 18LB WALL BALL
- (1) 25LB WALL BALL
- (2) 5 LB HEX DUMBBELLS
- (2) 10 LB HEX DUMBBELLS
- (2) 12.5 LB HEX DUMBBELLS
- (2) 15 LB HEX DUMBBELLS
- (2) 20 LB HEX DUMBBELLS
- (2) 25 LB HEX DUMBBELLS
- (2) 30 LB HEX DUMBBELLS
- (2) 35 LB HEX DUMBBELLS
- (2) 45 LB BUMPER PLATES
- (2) 25 LB BUMPER PLATES
- (2) 10 LB BUMPER PLATES

REPLACED MODEL #	NEW Model #	DYNAMIC RACK LINE - MSRP PRICING FEB 15, 2019- Update 3/8/19	2019 MSRP
		* Chrome wraps- Logo option	
		<i>* \$150 Wrap Logo Design Fee Per Order/Design</i>	
704012-99	700112-99	ULTRA PRO HALF RACK 8' (CHROME UPRIGHT WRAP)	\$ 3,833.46
704014-99	700114-99	ULTRA PRO POWER RACK 8' (CHROME UPRIGHT WRAP)	\$ 5,408.06
704015-99	700115-99	ULTRA PRO DOUBLE HALF RACK 8' (CHROME UPRIGHT WRAP)	\$ 7,796.83
704016-99	700116-99	ULTRA PRO DOUBLE HALF RACK SINGLE POST 8' (CHROME UPRIGHT WRAP)	\$ 6,637.19
704017-99	700117-99	ULTRA PRO POWER RACK/HALF RACK COMBO 8' (CHROME UPRIGHT WRAP)	\$ 9,313.87
704018-99	700118-99	ULTRA PRO POWER RACK/HALF RACK COMBO SINGLE POST 8' (CHROME UPRIGHT WRAP)	\$ 8,227.34
NEW ITEM	700119-99	ULTRA PRO DOUBLE POWER RACK 8' (CHROME UPRIGHT WRAP)	\$ 9,523.33

		* Powder coated wraps- Logo option	
		<i>* \$150 Wrap Logo Design Fee Per Order/Design</i>	
NEW ITEM	700102-99	ULTRA PRO G2 HALF RACK 8' (POWDER COATED UPRIGHT WRAP)	\$ 3,488
NEW ITEM	700104-99	ULTRA PRO G2 POWER RACK 8' (POWDER COATED UPRIGHT WRAP)	\$ 4,922
NEW ITEM	700105-99	ULTRA PRO G2 DOUBLE HALF RACK 8' (POWDER COATED UPRIGHT WRAP)	\$ 6,512
NEW ITEM	700106-99	ULTRA PRO G2 DOUBLE HALF RACK SINGLE POST 8' (POWDER COATED UPRIGHT WRAP)	\$ 5,839
NEW ITEM	700107-99	ULTRA PRO G2 POWER RACK/ HALF RACK COMBO 8' (POWDER COATED UPRIGHT WRAP)	\$ 8,086
NEW ITEM	700108-99	ULTRA PRO G2 POWER RACK/ HALF RACK COMBO SINGLE POST 8' (POWDER COATED UPRIGHT WRAP)	\$ 7,011
NEW ITEM	700109-99	ULTRA PRO G2 DOUBLE POWER RACK 8' (POWDER COATED UPRIGHT WRAP)	\$ 8,853

		* Powder coated wraps - DYNAMIC Logo	
*NO DESIGN OPTIONS			
NEW ITEM	700152-99	ULTRAPRO BASE HALF RACK 8'	\$ 3,275
NEW ITEM	700154-99	ULTRAPRO BASE POWER RACK 8'	\$ 4,667
NEW ITEM	700155-99	ULTRAPRO BASE DOUBLE HALF RACK 8'	\$ 3,833
NEW ITEM	700156-99	ULTRA PRO BASE DOUBLE HALF RACK SINGLE POST 8'	\$ 5,408
NEW ITEM	700159-99	ULTRA PRO BASE DOUBLE POWER RACK 8'	\$ 7,797

			\$ 6,637
			\$ 9,313.87
NEW ITEM	400112-99	TITAN G2 HALF RACK 8'	\$ 8,227
NEW ITEM	400114-99	TITAN G2 POWER RACK 8'	\$ 9,523
NEW ITEM	400115-99	TITAN G2 DOUBLE HALF RACK 8'	
NEW ITEM	400116-99	TITAN G2 DOUBLE HALF RACK SINGLE POST 8'	
NEW ITEM	400117-99	TITAN G2 POWER RACK/HALF RACK COMBO 8'	
NEW ITEM	400118-99	TITAN G2 POWER RACK/HALF RACK SINGLE POST COMBO 8'	\$ 3,488
NEW ITEM	400119-99	TITAN G2 DOUBLE POWER RACK 8'	\$ 4,922

			\$ 5,839.44
GLADIATOR RACKS	300012-99	GLADIATOR HALF RACK 8'	\$ 8,086
	300014-99	GLADIATOR POWER RACK 8'	\$ 7,011
	300016-99	GLADIATOR DOUBLE HALF RACK SINGLE POST 8'	\$ 8,853

CUSTOM ITEM #	Item Description	MSRP PRICING
WRAP-UP	CUSTOM CHARGE FOR UPRIGHT WRAP LOGO DESIGN- One time charge per design	\$ 300
BP-UP	CHARGE FOR COLORED BACKER PLATES BEHIND UPRIGHT WRAP- Cost per upright	\$ 60
PAD-UPCHARGE	CUSTOM CHARGE FOR COLOR PAD- Cost for each unit on order	\$ 80
XM-CUSTOM-LOGO	CUSTOM CHARGE FOR CONNECTOR BAR LOGO DESIGN- One time charge per design	\$ 150
BT-CUSTOM-LOGO	CUSTOM CHARGE FOR BALL TARGET LOGO DESIGN-One time charge per design	\$ 150
SCREEN-PRINT	CUSTOM CHARGE FOR SINGLE COLOR PRINT ON BUMPER PLATES-One time charge	\$ 150
SETUP-FEE-COLOR	CUSTOM CHARGE FOR NON STANDARD INK COLOR ON BUMPER PLATES-One time charge	\$ 400
SETUP-FEE-MULTI	CUSTOM CHARGE FOR SINGLE SPOT MULTI COLOR ON BUMPER PLATES- Cost for each unit on order	\$ 18
SETUP-FEE-MULTI3	CUSTOM CHARGE FOR FULL COLOR ON BUMPER PLATES- Cost for each unit on order	\$ 36
FSH-LOGOFT	CUSTOM CHARGE FOR PLYO LOGO-Cost for each unit on order	\$ 70

Model #	Item Description	2019 MSRP
ULTRA PRO RACK ATTACHMENTS		
<i>*Check quick finder for compatability</i>		
710009	LAT/ROW CABLE ATTACHMENT 300# STACKS	\$ 4,078
710011	DUAL FUNCTION TRAINER - 200# STACKS	\$ 6,088
710016	HI-LO CABLE COLUMN	\$ 3,274
709091	REVERSE HYPER ATTACHMENT	\$ 870
BH001	BASE BOLT ON BAR HOLDER	\$ 44
709045	HANGING 1 BAR STORAGE	\$ 26
BH002	DHR 2 HANGING BAR STORAGE	\$ 104
709058	BAR STORAGE (INSIDE RACK)	\$ 130
409012	WEIGHT PEG SINGLE	\$ 60
RECP-001	UNIVERSAL RECEPTACLE SINGLE	\$ 92
709056	REAR RACK RECEPTACLE SINGLE	\$ 66
709068	BOLT ON BAND PEGS W/ BUILT IN RECEPTACLE	\$ 343
709069	BASE MOUNTED BOLT ON BAND PEGS	\$ 178
709010	BAND PEG PAIR (REQ. RECEPTACLE)	\$ 194

709007	LANDMINE (REQ. RECEPTACLE)	\$ 108
709040	DUAL LANDMINE	\$ 312
709089	BAND PEG PAIR STORAGE HOLDERS (RACK MOUNTED)	\$ 26
709093	ACCESSORY HOOKS	\$ 14
709048	STORAGE HOOKS (PLATE)	\$ 32
709017	STORAGE HOOKS (PAIR)	\$ 72
709088	HALF RACK DIP	\$ 308
709098	POWER RACK REVERSE DIP	\$ 308
709090	HALF RACK JAMMER ARMS PAIR	\$ 836
709091	POWER RACK JAMMER ARMS PAIR	\$ 870
709032	DIP HANDLE PAIR (INDIVIDUAL ARMS)	\$ 428
709092	PLYO STEP	\$ 294
709035	ROPE PULL (ROPE NOT INCLUDED)	\$ 684
709041	SPLIT SQUAT ROLLER	\$ 302
709095	TECNIQUE TRAY PAIR	\$ 638
709049	BASE D-RING	\$ 42
709096	UPRIGHT D-RING	\$ 42
709002	SPOTTER STANDS	\$ 360
709033	BUMPER PLATE SIDE TABLE STORAGE	\$ 380
709094	FRAME MOUNT GHD	\$ 342
709075	FLYING PULL UP CONNECTED BALL TARGET (REQ. FLYING PULLUP)	\$ 180
709076	FLYING PULLUP	\$ 298
709077	95" MONKEY MOUNTAIN (POWER RACKS ONLY)	\$ 964
709078	43" BAND STORAGE XMEM	\$ 328
709079	XM PULLUP BALL (REQ. XD BAR)	\$ 44
709011	REVERSE SAFETIES (POWER RACK) (PAIR.)	\$ 600
709112	REVERSE J-CUP (LONG) (POWER RACK ONLY) PAIR	\$ 480
709113	REVERSE J-CUP (SHORT) (POWER RACK ONLY) PAIR	\$ 430
709220	4X3 MULTI-GRIP CHINUP	\$ 382
709097	HALF RACK BENCH LOCK-IN PLATES	\$ 278
709100	BENCH LOCK-IN PLATES	\$ 310
TITAN G2 RACK ATTACHMENTS		<i>*Check quick finder for compatability</i>
710009	LAT/ROW CABLE ATTACHMENT 300# STACKS	\$ 4,078
710011	DUAL FUNCTION TRAINER - 200# STACKS	\$ 6,088
710016	HI-LO CABLE COLUMN	\$ 3,274
709091	REVERSE HYPER ATTACHMENT	\$ 870
BH001	BASE BOLT ON BAR HOLDER	\$ 44
709045	HANGING 1 BAR STORAGE	\$ 26
BH002	DHR 2 HANGING BAR STORAGE	\$ 104
709058	BAR STORAGE (INSIDE RACK)	\$ 130
409012	WEIGHT PEG SINGLE	\$ 60
RECP-001	UNIVERSAL RECEPTACLE SINGLE	\$ 92
709056	REAR RACK RECEPTACLE SINGLE	\$ 66
709068	BOLT ON BAND PEGS W/ BUILT IN RECEPTACLE	\$ 343
709069	BASE MOUNTED BOLT ON BAND PEGS	\$ 178
709010	BAND PEG PAIR (REQ. RECEPTACLE)	\$ 194
709007	LANDMINE (REQ. RECEPTACLE)	\$ 108
709040	DUAL LANDMINE	\$ 312
709089	BAND PEG PAIR STORAGE HOLDERS (RACK MOUNTED)	\$ 26
709093	ACCESSORY HOOKS	\$ 14
709048	STORAGE HOOKS (PLATE)	\$ 32
709017	STORAGE HOOKS (PAIR)	\$ 72
409130	HALF RACK DIP	\$ 282
409130	POWER RACK REVERSE DIP	\$ 282
409082	HALF RACK JAMMER ARMS PAIR	\$ 568
409082	POWER RACK JAMMER ARMS PAIR	\$ 568
409131	PLYO STEP	\$ 294
409107	ROPE PULL (ROPE NOT INCLUDED)	\$ 276
409194	SPLIT SQUAT ROLLER	\$ 310
409046	TECNIQUE TRAY PAIR	\$ 644
709049	BASE D-RING	\$ 42
709096	UPRIGHT D-RING	\$ 42
709002	SPOTTER STANDS	\$ 360
709033	BUMPER PLATE SIDE TABLE STORAGE	\$ 380
709094	FRAME MOUNT GHD	\$ 342
709075	FLYING PULL UP CONNECTED BALL TARGET (REQ. FLYING PULLUP)	\$ 180
709076	FLYING PULLUP	\$ 298
709078	43" BAND STORAGE XMEM	\$ 328
709079	XM PULLUP BALL (REQ. XD BAR)	\$ 44
409220	3X3 MULTI-GRIP CHINUP	\$ 342
709097	HALF RACK BENCH LOCK-IN PLATES	\$ 278
709100	POWER RACK BENCH LOCK-IN PLATES	\$ 310
RACK CONNECTORS		
XM43BP-0001-LOGO-99	43" DOUBLE BAR XMEMBER (BACKER PLATE) -TITAN G2 BACK OF RACK ONLY	\$ 285

XM71-0001-99	71" DOUBLE BAR XMEMBER	\$ 217
XM71-0001-LOGO-99	71" DOUBLE BAR XMEMBER LOGO	\$ 335
XM71BP-0001-LOGO-99	71" DOUBLE BAR XMEMBER (BACKER PLATE)	\$ 447
XM71FP-0001-LOGO-99	71" DOUBLE BAR XMEMBER (FRONT PLATE)	\$ 420
XM71-0002-99	71" XD XMEMBER	\$ 245
XM71-0003-99	71" CHIN UP XMEMBER	\$ 282
XM71-0004-99	71" BAR XMEMBER	\$ 177
XM71-0005-99	71" DOUBLE BAR XMEMBER W/ TRX	\$ 287
XM71-0005-LOGO-99	71" LOGO DOUBLE BAR XMEMBER W/ TRX	\$ 310
XM71BP-0005-LOGO-99	71" DOUBLE BAR XMEMBER W/ TRX (BACKER PLATE)	\$ 430
XM71FP-0005-LOGO-99	71" DOUBLE BAR XMEMBER W/ TRX (FRONT PLATE)	\$ 430
XM71-0006-99	71" CHIN UP XMEMBER	\$ 440
XM71-0006-LOGO-99	71" CHIN UP XMEMBER (LOGO)	\$ 503
XM71FP-0006-LOGO-99	71" CHIN UP XMEMBER (FRONT PLATE)	\$ 625
XM95-0001-99	95" DOUBLE BAR XMEMBER	\$ 210
XM95-0001-LOGO-99	95" DOUBLE BAR XMEMBER LOGO	\$ 308
XM95BP-0001-LOGO-99	95" DOUBLE BAR XMEMBER (BACKER PLATE)	\$ 444
XM95FP-0001-LOGO-99	95" DOUBLE BAR XMEMBER (FRONT PLATE)	\$ 444
XM95-0002-99	95" XD XMEMBER	\$ 317
XM95-0003-99	95" CHIN UP XMEMBER	\$ 445
XM95-0004-99	95" XD SINGLE XMEMBER	\$ 236
XM95-0005-99	95" DOUBLE BAR XMEMBER W/ TRX	\$ 323
XM95-0005-LOGO-99	95" LOGO DOUBLE BAR XMEMBER W/ TRX	\$ 345
XM95BP-0005-LOGO-99	95" DOUBLE BAR XMEMBER W/ TRX (BACKER PLATE)	\$ 503
XM95FP-0005-LOGO-99	95" DOUBLE BAR XMEMBER W/ TRX (FRONT PLATE)	\$ 503
XM95-0006-99	95" CHIN UP XMEMBER	\$ 492
XM95-0006-LOGO-99	95" CHIN UP XMEMBER (LOGO)	\$ 570
XM95FP-0006-LOGO-99	95" CHIN UP XMEMBER (FRONT PLATE)	\$ 688
UNIVERSAL RACK ANNEX STORAGE		
ANX43BP-99	ANNEX 43" BUMPER PLATE STORAGE	\$ 206
ANX43BU-99	ANNEX 43" BOSU BALL STORAGE	\$ 185
ANX43DBM-99	ANNEX 43" M SADDLE DUMBBELL SHELF	\$ 347
ANX43DKB-99	ANNEX 43" DUMBBELL/KETTLEBELL SHELF	\$ 266
ANX43HK-99	ANNEX 43" HOOK STORAGE BAR	\$ 177
ANX43MB-99	ANNEX 43" MEDICINE BALL SHELF	\$ 190
ANX46BP-99	ANNEX 46" BUMPER PLATE STORAGE	\$ 234
ANX46BU-99	ANNEX 46" BOSU BALL STORAGE	\$ 189
ANX46DBM-99	ANNEX 46" M SADDLE DUMBBELL SHELF	\$ 336
ANX46DKB-99	ANNEX 46" DUMBBELL/KETTLEBELL SHELF	\$ 266
ANX46HK-99	ANNEX 46" HOOK STORAGE BAR	\$ 177
ANX46MB-99	ANNEX 46" MEDICINE BALL SHELF	\$ 194
ANX60BP-99	ANNEX 60" BUMPER PLATE STORAGE	\$ 307
ANX60BU-99	ANNEX 60" BOSU BALL STORAGE	\$ 253
ANX60DBM-99	ANNEX 60" M SADDLE DUMBBELL SHELF	\$ 381
ANX60DKB-99	ANNEX 60" DUMBBELL/KETTLEBELL SHELF	\$ 291
ANX60HK-99	ANNEX 60" HOOK STORAGE BAR	\$ 211
ANX60MB-99	ANNEX 60" MEDICINE BALL SHELF	\$ 240
ANX71BP-99	ANNEX 71" BUMPER PLATE STORAGE	\$ 373
ANX71BU-99	ANNEX 71" BOSU BALL STORAGE	\$ 303
ANX71DBM-99	ANNEX 71" M SADDLE DUMBBELL SHELF	\$ 505
ANX71DBS-99	ANNEX 71" STANDARD SADDLE DUMBBELL SHELF	\$ 545
ANX71DKB-99	ANNEX 71" DUMBBELL/KETTLEBELL SHELF	\$ 392
ANX71HK-99	ANNEX 71" HOOK STORAGE BAR	\$ 231
ANX71MB-99	ANNEX 71" MEDICINE BALL SHELF	\$ 260

DYNAMIC PLATE LOADED - SELECTORIZED LINE DEALER PRICING				2019
REPLACED MODEL #	NEW MODEL #	*See Sales for Availability*		MSRP
		Item Description	CATEGORY	
701003A	710003-99	ULTRA PRO CABLE STACK CROSS OVER - (2) 200 LB STACKS	MULTI-STACK MACHINE	\$ 6,272
701009	710009-99	ULTRA PRO CABLE STACK LAT/LOW ROW COMBO (Rack Mount) - 300 LB STACK	PIN SELECT - UPPER BODY	\$ 4,078
701010A	710010-99	ULTRA PRO FUNCTIONAL TRAINER (Stand Alone)	MULTI-STACK MACHINE	\$ 6,942
701011A	710011-99	ULTRA PRO FUNCTIONAL TRAINER (Rack Mount)	MULTI-STACK MACHINE	\$ 6,087
NEW ITEM	710013-99	ULTRA PRO 8-STACK JUNGLE SYSTEM - 250 LB/300 LB STACK	MULTI-STACK MACHINE	\$ 22,888
NEW ITEM	710019-99	ULTRA PRO 4-STACK JUNGLE SYSTEM - 250 LB/300 LB STACK	MULTI-STACK MACHINE	\$ 14,021
NEW ITEM	710045-99	ULTRA PRO 8-STACK HI/LO INSERT - 200 LB STACK	MULTI-STACK MACHINE	\$ 2,224
NEW ITEM	710046-99	ULTRA PRO 6-STACK JUNGLE SYSTEM - 250LB/300 LB STACKS	MULTI-STACK MACHINE	\$ 18,606
NEW ITEM	710050-99	ULTRA PRO STANDARD CUBE - FRAME ONLY	MULTI-STACK MACHINE	\$ 1,487
NEW ITEM	710051-99	ULTRA PRO CUBE - (4) ADJUSTABLE CABLE COLUMN - 250 LB STACK	MULTI-STACK MACHINE	\$ 11,431
NEW ITEM	710052-99	ULTRA PRO CUBE - (2) LAT PULL AND (2) SEATED ROW - 250 LB/300 LB STACKS	MULTI-STACK MACHINE	\$ 2,140
NEW ITEM	710053-99	ULTRA PRO 12-STACK JUNGLE SYSTEM - 250 LB/300 LB STACKS	MULTI-STACK MACHINE	\$ 36,360
NEW ITEM	711015-99	ULTRA PRO LEG EXTENSION MACHINE -200 LB STACK	PIN SELECT - LOWER BODY	\$ 4,685
NEW ITEM	711027-99	ULTRA PRO PRONE LEG CURL MACHINE - 200 LB STACK	PIN SELECT - LOWER BODY	\$ 3,627
NEW ITEM	711029-99	ULTRA PRO STANDING CALF MACHINE - 400 LB STACK	PIN SELECT - LOWER BODY	\$ 4,503
NEW ITEM	711031-99	ULTRA PRO KNEELING LEG CURL MACHINE - 200 LB STACK	PIN SELECT - LOWER BODY	\$ 4,007

NEW ITEM	711038-99	ULTRA PRO GLUTE ISOLATOR MACHINE - 200 LB STACK	PIN SELECT - LOWER BODY	\$ 4,932
701002RM	710016-99	ULTRA PRO SINGLE STACK TRAINER (Rack Mount)	PIN SELECT - UPPER BODY	\$ 3,275
NEW ITEM	710047-99	ULTRA PRO ADJUSTABLE COLUMN ADD ON - 250 LB STACK	PIN SELECT - UPPER BODY	\$ 2,517
NEW ITEM	710048-99	ULTRA PRO LAT PULLDOWN ADD ON - 300 LB STACK	PIN SELECT - UPPER BODY	\$ 2,978
NEW ITEM	710049-99	ULTRA PRO SEATED ROW ADD ON - 300 LB STACK	PIN SELECT - UPPER BODY	\$ 2,458
701001	712001-99	ULTRA PRO CABLE STACK LAT/LOW ROW COMBO (Stand Alone) - 300 LB STACK	PIN SELECT - UPPER BODY	\$ 3,839
701002A	712002-99	ULTRA PRO ADJUSTABLE HI/LOW MACHINE - 200 LB STACK	PIN SELECT - UPPER BODY	\$ 3,232
NEW ITEM	712028-99	ULTRA PRO REAR DELT/PEC MACHINE - 250 LB STACK	PIN SELECT - UPPER BODY	\$ 5,309
NEW ITEM	712037-99	ULTRA PRO BICEP CURL BENCH MACHINE - 200 LB STACK	PIN SELECT - UPPER BODY	\$ 3,640
	700017-99	ICONIC 5 DEGREE REVERSE HYPER - (PL)	PLATE LOADED - LOWER BODY	\$ 1,999
	700018A-99	ICONIC INVERSE CURL - (PL)	PLATE LOADED - LOWER BODY	\$ 3,358
NEW ITEM	701370-99	GMAX ULTRA PRO GLUTE BRIDGE - 200 LB STACK	PIN SELECT - LOWER BODY	\$ 4,399
NEW ITEM	701371-99	G-MAX GLUTE BRIDGE LIGHT COMMERCIAL - USES BANDS (Black Pad Only)	BANDS - GLUTES	\$ 1,598
NEW ITEM	714000-99	ULTRA PRO VERTICAL LEG PRESS - (PL)	PLATE LOADED - LOWER BODY	\$ 6,563
NEW ITEM	714002-99	ULTRA PRO LEG PRESS - (PL)	PLATE LOADED - LOWER BODY	\$ 7,374
NEW ITEM	714003-99	ULTRA PRO UNI-LATERAL LEG PRESS - (PL)	PLATE LOADED - LOWER BODY	\$ 9,969
NEW ITEM	714004-99	ULTRA PRO HACK SQUAT - (PL)	PLATE LOADED - LOWER BODY	\$ 7,513
NEW ITEM	714005-99	ULTRA PRO POWER SQUAT - (PL)	PLATE LOADED - LOWER BODY	\$ 5,353
NEW ITEM	714016-99	ULTRA PRO PRO SEATED CALF RAISE - (PL)	PLATE LOADED - LOWER BODY	\$ 2,360
NEW ITEM	720080-99	ULTRA PRO HYPER/GHD COMBO	PLATE LOADED - LOWER BODY	\$ 4,869
702002	713002-99	ULTRA PRO LAT LOW ROW COMBO - (PL)	PLATE LOADED - UPPER BODY	\$ 2,920
702003	713003-99	ULTRA PRO FREE STANDING JAMMER - (PL)	PLATE LOADED - UPPER BODY	\$ 3,874
NEW ITEM	713007-99	ULTRA PRO COUNTER BALANCE SMITH MACHINE - (PL)	PLATE LOADED - UPPER BODY	\$ 6,578
NEW ITEM	713008-99	ULTRA PRO UNI-LATERAL CONVERGING INCLINE CHEST PRESS - (PL)	PLATE LOADED - UPPER BODY	\$ 4,057
NEW ITEM	713009-99	ULTRA PRO UNI-LATERAL FLAT CHEST PRESS - (PL)	PLATE LOADED - UPPER BODY	\$ 3,371
NEW ITEM	713010-99	ULTRA PRO UNI-LATERAL CONVERGING SHOULDER PRESS - (PL)	PLATE LOADED - UPPER BODY	\$ 3,456
NEW ITEM	713011-99	ULTRA PRO UNI-LATERAL CONVERGING LOW ROW - (PL)	PLATE LOADED - UPPER BODY	\$ 3,931
NEW ITEM	713021-99	ULTRA PRO TRAP/SHRUG/SQUAT - (PL)	PLATE LOADED - UPPER BODY	\$ 2,917
NEW ITEM	713025-99	ULTRA PRO INCLINE LEVER ROW - (PL)	PLATE LOADED - UPPER BODY	\$ 2,493
700030A	713030-99	HEAD AND NECK ISOLATOR MACHINE - (PL)	PLATE LOADED - UPPER BODY	\$ 3,455
NEW ITEM	713034-99	ULTRA PRO BICEP CURL - (PL)	PLATE LOADED - UPPER BODY	\$ 2,710
NEW ITEM	713035-99	ULTRA PRO TRICEP KICK BACK - (PL)	PLATE LOADED - UPPER BODY	\$ 1,924
NEW ITEM	713036-99	ULTRA PRO UNI-LATERAL CONVERGING LAT PULLDOWN - (PL)	PLATE LOADED - UPPER BODY	\$ 3,143
NEW ITEM	708023-99	ULTRA PRO HORIZONTAL 10 BARBELL RACK	STORAGE	\$ 998
CHANGED SKUS		<i>*Also see "Training Products" Tab</i>		
509072	719072-99	ULTRA PRO DIP/AB	BODY WEIGHT-UPPER BODY & CORE	\$ 1,648
509074	719074-99	ULTRA PRO 45 DEGREE HYPER EXTENSION	BODY WEIGHT-UPPER BODY & CORE	\$ 1,282
NEW ITEM	716012-99	ULTRA PRO ANGLED ROW BENCH	FREE WEIGHT - UPPER BODY	\$ 2,153
NEW ITEM	716017-99	ULTRA PRO STANDING PREACHER CURL	FREE WEIGHT - UPPER BODY	\$ 1,931
NEW ITEM	716020-99	ULTRA PRO DUMBBELL TRICEP BENCH	FREE WEIGHT - UPPER BODY	\$ 722
NEW ITEM	716030-99	ULTRA PRO DUMBBELL PULLOVER BENCH	FREE WEIGHT - UPPER BODY	\$ 1,897
NEW ITEM	716073-99	ULTRA PRO SEATED PREACHER CURL	FREE WEIGHT - UPPER BODY	\$ 1,498
NEW ITEM	717001-99	ULTRA PRO SISSY SQUAT	BODY WEIGHT - LOWER BODY	\$ 779
NEW ITEM	718022-99	ULTRA PRO FIXED SEAT UTILITY BENCH	FREE WEIGHT - UTILITY BENCHES	\$ 857
NEW ITEM	718026-99	ULTRA PRO ADJUSTABLE LUMBAR UTILITY BENCH	FREE WEIGHT - UTILITY BENCHES	\$ 1,558
NEW ITEM	718032-99	ULTRA PRO ADJUSTABLE AB BENCH	FREE WEIGHT - UTILITY BENCHES	\$ 3,092
NEW ITEM	715018-99	ULTRA PRO OLYMPIC INCLINE BENCH W/ OLYMPIC PLATE STORAGE	FREE WEIGHT - OLYMPIC BENCH	\$ 2,331
NEW ITEM	715024-99	ULTRA PRO OLYMPIC FLAT BENCH W/ OLYMPIC PLATE STORAGE	FREE WEIGHT - OLYMPIC BENCH	\$ 1,670
NEW ITEM	715033-99	ULTRA PRO OLYMPIC DECLINE BENCH W/ OLYMPIC PLATE STORAGE	FREE WEIGHT - OLYMPIC BENCH	\$ 2,773
509064	715064-99	ULTRA PRO OLYMPIC FLAT COMPETION BENCH	FREE WEIGHT - OLYMPIC BENCH	\$ 1,862
709060	718060-99	ULTRA PRO ADJUSTABLE LADDER BENCH	FREE WEIGHT - UTILITY BENCHES	\$ 1,478
709060SS	718060SS-99	ULTRA PRO ADJUSTABLE LADDER BENCH w/SPOTTER	FREE WEIGHT - UTILITY BENCHES	\$ 1,698
709061	718061-99	ULTRA PRO FLAT UTILITY BENCH	FREE WEIGHT - UTILITY BENCHES	\$ 458
709062	718062-99	ULTRA PRO DECLINE UTILITY BENCH	FREE WEIGHT - UTILITY BENCHES	\$ 1,492
709063	718063-99	ULTRA PRO ADJUSTABLE 4-WAY FID BENCH	FREE WEIGHT - UTILITY BENCHES	\$ 1,778
709070	720070-99	ULTRA PRO LINEAR GLUTE/HAM DEVELOPER	GLUTE/HAM DELVELOPERS	\$ 2,626
709071	720071-99	ULTRA PRO LINEAR GLUTE/HAM DEVELOPER w/KNEE PAD	GLUTE/HAM DELVELOPERS	\$ 2,452
709072	720072-99	ULTRA PRO WALK THRU GLUTE/HAM DEVELOPER	GLUTE/HAM DELVELOPERS	\$ 2,748
709073	720073-99	ULTRA PRO WALK THRU GLUTE/HAM DEVELOPER w/KNEE PAD	GLUTE/HAM DELVELOPERS	\$ 2,920

PLATE LOADED LINE PAD SLIP COVERS			
BSC-714002-PLN-99		SLIPCOVER PLAIN FPAD-050	\$ 52
BSC-714002-PRNT-99		SLIPCOVER-PRINTED LOGO FPAD-050	\$ 121
BSC-713008-PLN-99		SLIPCOVER PLAIN FPAD-042	\$ 50
BSC-713008-PRNT-99		SLIPCOVER PRINTED LOGO FPAD-042	\$ 121
BSC-713009-PLN-99		SLIPCOVER PLAIN FPAD-042	\$ 50
BSC-713009-PRNT-99		SLIPCOVER PRINTED LOGO FPAD-042	\$ 121
BSC-713010-PLN-99		SLIPCOVER PLAIN FPAD-084	\$ 50
BSC-713010-PRNT-99		SLIPCOVER PRINTED LOGO FPAD-084	\$ 121
BSC-711015-PLN-99		SLIPCOVER PLAIN FPAD-057	\$ 50
BSC-711015-PRNT-99		SLIPCOVER PRINTED LOGO FPAD-057	\$ 121
BSC-715018-PLN-99		SLIPCOVER PLAIN-FPAD-044	\$ 50
BSC-715018-PRNT-99		SLIPCOVER PRINTED LOGO FPAD-044	\$ 121

BSC-718022-PLN-99	SLIPCOVER PLAIN FPAD-051	\$ 50
BSC-718022-PRNT-99	SLIPCOVER PRINTED LOGO FPAD-051	\$ 121
BSC-715024-PLN-99	SLIPCOVER PLAIN FPAD-085	\$ 50
BSC-715024-PRNT-99	SLIPCOVER PRINTED LOGO FPAD-085	\$ 121
BSC-718026-PLN-99	SLIPCOVER-PLAIN FPAD-083	\$ 50
BSC-718026-PRNT-99	SLIPCOVER PRINTED LOGO FPAD-083	\$ 121
BSC-712028-PLN-99	SLIPCOVER PLAIN FPAD-077	\$ 50
BSC-712028-PRNT-99	SLIPCOVER PRINTED LOGO-FPAD-077	\$ 121
BSC-715033-PLN-99	SLIPCOVER-PLAIN FPAD-086	\$ 50
BSC-715033-PRNT-99	SLIPCOVER PRINTED LOGO FPAD-086	\$ 121
BSC-713035-PLN-99	SLIPCOVER PLAIN FPAD-065	\$ 50
BSC-713035-PRNT-99	SLIPCOVER PRINTED LOGO FPAD-065	\$ 121

BENCHES, GHDS, SLEDS, STORAGE RACKS, PLYOS, SLEDS, PLATFORMS		2019
Model #	Item Description	MSRP
BODY WEIGHT MACHINES		
719072-99	ULTRA PRO DIP/AB	\$ 1,648
719074-99	ULTRA PRO 45 DEGREE HYPER EXTENSION	\$ 1,282
717001-99	ULTRA PRO SISSY SQUAT	\$ 779
FREE WEIGHT BENCHES		
716012-99	ULTRA PRO ANGLED ROW BENCH	\$ 2,153
716017-99	ULTRA PRO STANDING PREACHER CURL	\$ 1,931
716020-99	ULTRA PRO DUMBBELL TRICEP BENCH	\$ 722
716030-99	ULTRA PRO DUMBBELL PULLOVER BENCH	\$ 1,897
716073-99	ULTRA PRO SEATED PREACHER CURL	\$ 1,498
715018-99	ULTRA PRO OLYMPIC INCLINE BENCH W/ OLYMPIC PLATE STORAGE	\$ 2,331
715024-99	ULTRA PRO OLYMPIC FLAT BENCH W/ OLYMPIC PLATE STORAGE	\$ 1,670
715033-99	ULTRA PRO OLYMPIC DECLINE BENCH W/ OLYMPIC PLATE STORAGE	\$ 2,773
715064-99	ULTRA PRO OLYMPIC FLAT COMPETION BENCH	\$ 1,862
BENCHES		
109060	ACCELL BENCH - ADJUSTABLE 0-85 DEG INCLINE LADDER 10 PAD W/ WHEELS	\$ 957
109060LI	ACCELL BENCH - ADJUSTABLE 0-85 DEG INCLINE LADDER 10IN PAD LOCK-IN W/ WHEELS	\$ 1,068
109060LP	ACCELL BENCH - ADJUSTABLE 0-85 DEG INCLINE LADDER LARGE PAD 14IN PAD W/ WHEELS	\$ 1,187
109060SS	ACCELL BENCH - ADJUSTABLE 0-85 DEG INCLINE LADDER 10IN PAD LOCK-IN SPOTTER PLATFORMS W/ WHEELS	\$ 1,067
109060SU	ACCELL BENCH - ADJUSTABLE 0-85 DEG INCLINE LADDER 10IN PAD STAND UP W/ WHEELS	\$ 990
109061	ACCELL BENCH - STANDARD FLAT 2 X2 FRAME 10 X44 PAD 18 HEIGHT W/ WHEELS	\$ 409
509060	EDGE BENCH - ADJUSTABLE 0-85 DEG INCLINE POP PIN 10 PAD W/ WHEELS	\$ 959
509060SU	EDGE BENCH - ADJUSTABLE 0-85 DEG INCLINE POP PIN 10 PAD STAND UP W/ WHEELS	\$ 993
509062	EDGE BENCH - DECLINE/SIT UP -10 TO -30 DEG W/ WHEELS	\$ 1,552
509063	EDGE BENCH - ADJUSTABLE FLAT/INCLINE/DECLINE -15DEG TO +85DEG W/ WHEELS	\$ 1,856
718022-99	ULTRA PRO FIXED SEAT UTILITY BENCH	\$ 857
718026-99	ULTRA PRO ADJUSTABLE LUMBAR UTILITY BENCH	\$ 1,558
718032-99	ULTRA PRO ADJUSTABLE AB BENCH	\$ 3,092
718060-99	ULTRA PRO ADJUSTABLE LADDER BENCH	\$ 1,478
709060LI	ULTRA PRO BENCH - ADJUSTABLE 0-85 DEG INCLINE LADDER 12 PAD STAND UP LOCK-IN SPOTTER PLATFORMS	\$ 1,773
709060SP	ULTRA PRO BENCH - ADJUSTABLE 0-85 DEG INCLINE LADDER 10 PAD STAND UP W/ WHEELS	\$ 1,289
718060SS-99	ULTRA PRO ADJUSTABLE LADDER BENCH W/SPOTTER	\$ 1,698
718061-99	ULTRA PRO FLAT UTILITY BENCH	\$ 458
718062-99	ULTRA PRO DECLINE UTILITY BENCH	\$ 1,492
718063-99	ULTRA PRO ADJUSTABLE 4-WAY FID BENCH	\$ 1,778
715064-99	ULTRA PRO OLYMPIC FLAT COMPETION BENCH	\$ 1,862
BENCH ATTACHMENTS		
109101	ATTACHMENT - ACCELL BENCH - STAND UP ATTACHMENT BOLT ON (COMPATIBLE WITH ALL 109060 VARIATIONS)	\$ 32
509101	STANDING BENCH ATTACHMENT (509060 ONLY)	\$ 46
BENCH SLIP COVERS (EMBROIDERED OPTIONS AVAILABLE)		
<i>*must provide vector logo exactly as to be printed - logo design/vectorizing available for 75.00 design fee</i>		
BSC-109060LP-PLN-99	SLIPCOVER PLAIN FPAD-022	\$ 50
BSC-109060LP-PRNT-99	SLIPCOVER PRINTED LOGO FPAD-022	\$ 121
BSC-109060-PLN-99	SLIPCOVER PLAIN FPAD-001	\$ 50
BSC-109060-PRNT-99	SLIP COVER PRINTED LOGO FPAD-001	\$ 121
BSC-109061-PLN-99	SLIPCOVER PLAIN FPAD-003	\$ 50
BSC-109061-PRNT-99	SLIPCOVER PRINTED LOGO FPAD-003	\$ 121
BSC-509062-PLN-99	SLIPCOVER PLAIN FPAD-007	\$ 50
BSC-509062-PRNT-99	SLIPCOVER PRINTED LOGO FPAD-007	\$ 121
BSC-509063-PLN-99	SLIPCOVER PLAIN FPAD-012	\$ 50
BSC-509063-PRNT-99	SLIPCOVER PRINTED LOGO FPAD-012	\$ 121
BSC-509064-PLN-99	SLIPCOVER PLAIN FPAD-003	\$ 50
BSC-509064-PRNT-99	SLIPCOVER PRINTED LOGO FPAD-003	\$ 121
BSC-509072-PLN-99	SLIPCOVER PLAIN FPAD-019	\$ 50
BSC-509072-PRNT-99	SLIPCOVER PRINTED LOGO FPAD-019	\$ 121
BSC-709060-PLN-99	SLIPCOVER PLAIN FPAD-022	\$ 50
BSC-709060-PRNT-99	SLIPCOVER PRINTED LOGO FPAD-022	\$ 121
BSC-718060-PLN-99	SLIPCOVER PLAIN FPAD-022	\$ 50
BSC-718060-PRNT-99	SLIPCOVER PRINTED LOGO FPAD-022	\$ 120

BSC-718061-PLN-99	SLIPCOVER PLAIN FPAD-003	\$ 50
BSC-718061-PRINT-99	SLIPCOVER PRINTED LOGO FPAD-003	\$ 121
BSC-718062-PLN-99	SLIPCOVER PLAIN FPAD-007	\$ 50
BSC-718062-PRNT-99	SLIPCOVER PRINTED LOGO FPAD-007	\$ 120
BSC-718063-PLN-99	SLIPCOVER PLAIN FPAD-012	\$ 50
BSC-718063-PRNT-99	SLIPCOVER PRINTED LOGO FPAD-012	\$ 120
BSC-709061-PLN-99	SLIPCOVER PLAIN FPAD-003	\$ 50
BSC-709061-PRNT-99	SLIPCOVER PRINTED LOGO FPAD-003	\$ 121
GHD		
110000	ECONOMY GHD - GLUTE HAM DEVELOPER ADJUSTABLE W/ SPLIT PAD	\$ 798
109071	ACCELL GHD - GLUTE HAM DEVELOPER ADJUSTABLE W/ SPLIT PAD	\$ 1,942
509071	EDGE GHD - GLUTE HAM DEVELOPER ADJUSTABLE W/ SPLIT PAD	\$ 2,205
720070-99	ULTRA PRO LINEAR GLUTE/HAM DEVELOPER	\$ 2,626
720071-99	ULTRA PRO LINEAR GLUTE/HAM DEVELOPER W/KNEE PAD	\$ 2,452
720072-99	ULTRA PRO WALK THRU GLUTE/HAM DEVELOPER	\$ 2,748
720073-99	ULTRA PRO WALK THRU GLUTE/HAM DEVELOPER W/KNEE PAD	\$ 2,920
STORAGE RACKS		
109080	ACCELL STORAGE - 2 TIER KETTLEBELL RACK 60 WIDTH	\$ 551
109081	ACCELL BAR STORAGE - 10-BARS WALL MOUNTED RACK	\$ 344
109082	ACCELL BAR STORAGE - 5-BARS 36 FLOOR X-BAR	\$ 250
109083	ACCELL STORAGE - 3 TIER DUMBBELL RACK 60IN WIDTH	\$ 900
109084A	STORAGE - BUMPER PLATE - SINGLE POST W/WHEELS	\$ 376
109107	A-FRAME OLYMPIC PLATE STORAGE	\$ 287
109108	A-FRAME BUMPER PLATE STORAGE	\$ 288
509084	EDGE VERTICAL BUMPER TREE - 5 PLATE PEGS W/2-BAR CUPS	\$ 594
509085	EDGE HORIZONTAL ROLLING BUMPER STORAGE - 43IN RACK WIDTH W/ WHEELS	\$ 550
509086	STORAGE-ROLLING PLATE RACK	\$ 543
109085	ACCELL BAR STORAGE - 9-BARS 18 X18 FLOOR BOX	\$ 248
109086	ACCELL STORAGE - MAT RACK 72 HEIGHT W/ CASTERS	\$ 667
109088	ACCELL MAT STORAGE - MAT RACK 48 HEIGHT W/ CASTERS	\$ 554
109089	ACCELL BALL STORAGE - MEDICINE BALL RACK VERTICAL (4-BALL)	\$ 224
509080A	EDGE STORAGE - 2 TIER DUMBBELL RACK (8FT4IN) SADDLES (12 PAIR)	\$ 1,325
509081A	EDGE STORAGE - 3 TIER DUMBBELL RACK (8'4") SADDLES (18 PAIR)	\$ 1,865
509082	EDGE STORAGE - 2-TIER HEX DUMBBELL RACK 8FT 4IN (UP TO 12 PAIR)	\$ 1,192
509083	EDGE STORAGE - 3-TIER HEX DUMBBELL RACK 8FT 4IN (UP TO 18 PAIR)	\$ 1,602
509105	EDGE STORAGE - 2 TIER DUMBBELL RACK - SADDLES (10 PAIR)	\$ 1,220
509096	EDGE STORAGE - 3 TIER DUMBBELL RACK - SADDLES (15 PAIR)	\$ 1,698
400020	ARSENAL STORAGE UNIT - SAFE 10 WIDTH	\$ 5,819
400021	ARSENAL SAFE 10FT STORAGE UNIT W/MATING BOLT - ACCESSORIES NOT INCLUDED	\$ 6,109
400022	ARSENAL STORAGE UNIT - LOCKER 6 WIDTH	\$ 3,849
400023	ARSENAL LOCKER 6FT STORAGE UNIT W/MATING BOLT - ACCESSORIES NOT INCLUDED	\$ 4,090
400024	ARSENAL STORAGE UNIT - VAULT 16 WIDTH	\$ 7,487
STEEL PLYOS		
109090	ACCELL PLYO BOX STARTER SET - 12 18 24 30	\$ 1,244
109091	ACCELL PLYO BOX INTERMEDIATE SET - 12 18 24 30 36	\$ 1,590
109092	ACCELL PLYO BOX - 6 - STANDARD	\$ 230
109093	ACCELL PLYO BOX - 12 - STANDARD	\$ 271
109094	ACCELL PLYO BOX - 18 - STANDARD	\$ 311
109095	ACCELL PLYO BOX - 24 - STANDARD	\$ 346
109096	ACCELL PLYO BOX - 30 - STANDARD	\$ 362
109097	ACCELL PLYO BOX - 36 - STANDARD	\$ 408
109098	ACCELL PLYO BOX - 42 - STANDARD	\$ 428
SLEDS		
109990	ACCELL SLED - POWER	\$ 762
109991	ACCELL SLED - POWER W/ REMOVABLE HARD SURFACE FEET	\$ 911
109992	ACCELL SLED - HI-LO TRAINING W/ FIXED HANDLE	\$ 586
109996	ACCELL SLED - HI-LO TRAINING W/ ADJUSTABLE HANDLE	\$ 528
109997	ACCELL SLED - COMPACT POWER SINGLE HOOK	\$ 396
109998	ACCELL SLED - COMPACT POWER DOUBLE HOOK W/ SKIS	\$ 476
OTHER STATIONS		
109993	ACCELL STATION - SINGLE CHIN BAR 4 WIDTH 26 DEPTH WALL-MOUNTED (MOUNTING HARDWARE NOT INCLUDED)	\$ 302
109994	ACCELL STATION - TRI CHIN BAR 96 WIDTH 17.5 DEPTH WALL-MOUNTED (MOUNTING HARDWARE NOT INCLUDED)	\$ 561
109995	ACCELL STATION - ADJUSTABLE SQUAT BOX 17IN-24IN	\$ 424
STAND ALONE PLATFORMS		
PLTFM-RAMP	PLATFORM RAMP ATTACHMENT	\$ 163
PLTSA-483-LOGO	ACCELL STAND ALONE 4 X 8 X 3 PLATFORM W/ URETHANE LOGO	\$ 2,240
PLTSA-483	ACCELL STAND ALONE 4 X 8 X 3 PLATFORM	\$ 1,940
PLTSA-683-LOGO	ACCELL STAND ALONE 6 X 8 X 3 PLATFORM W/ URETHANE LOGO	\$ 2,600
PLTSA-683	ACCELL STAND ALONE 6 X 8 X 3 PLATFORM	\$ 2,300

PLATES, BARS, DBS, KBS, BALLS, BANDS, ASSORTED		2019
Model #	Item Description	MSRP
STANDARD BUMPER PLATES		
PL-BP-10B	BUMPER PLATE-BLK 17.7IN-10LB (PAIR)	\$ 46

PL-BP-15B	BUMPER PLATE-BLK 17.7IN-15LB (PAIR)	\$ 87
PL-BP-25B	BUMPER PLATE-BLK 17.7IN-25LB (PAIR)	\$ 129
PL-BP-35B	BUMPER PLATE-BLK 17.7IN-35LB (PAIR)	\$ 157
PL-BP-45B	BUMPER PLATE-BLK 17.7IN-45LB (PAIR)	\$ 205
PL-BP-SET-260B	BUMPER PLATE-BLK-SET-260 LB (2X10 2X15 2X25 2X35 2X45)	\$ 747
PL-BP-SET-1000B	BUMPER PLATE-BLK-SET-1000 LB (10X10 4X15 10X25 4X35 10X45)	\$ 2,992
PL-BP-10-GR	BUMPER PLATE-GRN 17.7IN-10LB (PAIR)	\$ 66
PL-BP-25-YE	BUMPER PLATE-YEL 17.7IN-25LB (PAIR)	\$ 150
PL-BP-35-BL	BUMPER PLATE-BLU 17.7IN-35LB (PAIR)	\$ 173
PL-BP-45-RD	BUMPER PLATE-RED 17.7IN-45LB (PAIR)	\$ 331
PL-BP-SET-260COLOR	BUMPER PLATE-COL-SET-260 LB (2X10GR 2X15B 2X25YE 2X35BL 2X45RD)	\$ 953
PL-BP-SET-1000COLOR	BUMPER PLATE-COL-SET-1000 LB (10X10GR 4X15B 10X25YE 4X35BL 10X45RD)	\$ 3,702
PL-BP-10-HI	BUMPER PLATE-HI IMPACT-10LB (PAIR)	\$ 63
PL-BP-15-HI	BUMPER PLATE-HI IMPACT-15LB (PAIR)	\$ 93
PL-BP-25-HI	BUMPER PLATE-HI IMPACT-25LB (PAIR)	\$ 137
PL-BP-35-HI	BUMPER PLATE-HI IMPACT-35LB (PAIR)	\$ 182
PL-BP-45-HI	BUMPER PLATE-HI IMPACT-45LB (PAIR)	\$ 222
PL-BP-SET-160HI	BUMPER PLATE-HIGH IMPACT-SET-160 LB (2X10 2X25 2X45)	\$ 408
PL-BP-SET-260HI	BUMPER PLATE-HIGH IMPACT-SET-260 LB (2X10 2X15 2X25 2X35 2X45)	\$ 674
PL-BP-SET-1000HI	BUMPER PLATE-HIGH IMPACT-SET-1000 LB (10X10 4X15 10X25 4X35 10X45)	\$ 2,572

COMPETITION TRAINING COMP PLATES (KG OPTIONS AVAILABLE)

*One color Screen printing - 75.00 design fee per plate size - select color options only (white standard)
 *Multi Color Logo (includes lettering) - 12.00 per pair + 75.00 design fee

PL-BP-10B-OS-COMP-LOGO	10LB BLACK OS ECON PLATE W/LOGO OPTION	\$ 120
PL-BP-10-COMP-UB	10LB URETHANE COMPETITION BUMPER PLATE-BLACK	\$ 246
PL-BP-10-COMP-UB-LOGO	10LB URETHANE COMPETITION BUMPER PLATE-BLACK	\$ 240
PL-BP-25B-COMP	COMPETITION BUMPER PLATE-BLACK 17.7IN-25LB	\$ 286
PL-BP-25B-COMP-LOGO	COMPETITION BUMPER PLATE-BLACK 17.7IN-25LB	\$ 286
PL-BP-25-COMP	BUMPER PLATE - COMPETITION GREEN 17.7 25LB (PAIR)	\$ 309
PL-BP-25-COMP-UB	25LB URETHANE COMPETITION BUMPER PLATE-BLACK	\$ 358
PL-BP-35B-COMP	BUMPER PLATE - COMPETITION BLACK 17.7 35LB (PAIR)	\$ 346
PL-BP-35B-COMP-LOGO	COMPETITION BUMPER PLATE-BLACK 17.7IN-35LB	\$ 346
PL-BP-35-COMP	COMPETITION BUMPER PLATE-YELLOW 17.7IN-35LB	\$ 397
PL-BP-35-COMP-LOGO	COMPETITION BUMPER PLATE-YELLOW 17.7IN-35LB	\$ 397
PL-BP-35-COMP-UB	35LB URETHANE COMPETITION BUMPER PLATE-BLACK	\$ 456
PL-BP-45B-COMP	COMPETITION BUMPER PLATE-BLACK 17.7IN-45LB	\$ 423
PL-BP-45B-COMP-LOGO	COMPETITION BUMPER PLATE-BLACK 17.7IN-45LB	\$ 429
PL-BP-45-COMP	COMPETITION BUMPER PLATE-BLUE 17.7IN-45LB	\$ 469
PL-BP-45-COMP-LOGO	COMPETITION BUMPER PLATE-BLUE 17.7IN-45LB	\$ 486
PL-BP-45-COMP-UB	45LB URETHANE COMPETITION BUMPER PLATE-BLACK	\$ 571
PL-BP-55B-COMP	BUMPER PLATE - COMPETITION BLACK 17.7 55LB (PAIR)	\$ 474
PL-BP-55B-COMP-LOGO	COMPETITION BUMPER PLATE-BLACK 17.7"-55LB	\$ 474
PL-BP-55-COMP	COMPETITION BUMPER PLATE-RED 17.7IN-55LB	\$ 566
PL-BP-55-COMP-LOGO	COMPETITION BUMPER PLATE-RED 17.7"-55LB	\$ 549
PL-BP-55-COMP-UB	55LB URETHANE COMPETITION BUMPER PLATE-BLACK	\$ 653

COMPETITION CHANGE PLATES

*One color Screen printing - 75.00 design fee per plate size - select color options only (white standard)
 *Multi Color Logo (includes lettering) - 12.00 per pair + 75.00 design fee

PL-BP-2.5B-UB	2.5LB URETHANE CHANGE PLATE-BLACK	\$ 86
PL-BP-5B-UB	5LB URETHANE CHANGE PLATE-BLACK	\$ 114

BARs

*.99 indicates logo option - 75.00 Design Fee per bar size

608000	BAR - OLYMPIC 20KG - BLACK ZINC - 28.55MM DIA - 194K MIN TENSIL	\$ 543
608000-99	BAR - OLYMPIC 20KG - BLACK ZINC - 28.55MM DIA - 194K MIN TENSIL	\$ 592
608001	BAR - OLYMPIC 15KG - BLACK ZINC - 25MM DIA - 168 MIN TENSIL (WOMENS BAR)	\$ 480
608001-99	BAR - OLYMPIC 15KG - BLACK ZINC - 25MM DIA - 168 MIN TENSIL (WOMENS BAR)	\$ 530
608002	BAR - TRAINING - 15LB - ALUMINUM	\$ 347
608002-99	BAR - TRAINING - 15LB - ALUMINUM	\$ 396
608003	BAR - POWER - 45LB - 1200LB 32MM DIA	\$ 420
608003-99	BAR - POWER - 45LB - 1200LB 32MM DIA	\$ 470
608004	BAR - POWER - 45LB - 1200LB 28.5MM DIA - CENTER KNURL	\$ 522
608004-99	BAR - POWER - 45LB - 1200LB 28.5MM DIA - CENTER KNURL	\$ 572
608005	SOLID HEX/TRAP BAR - 56IN	\$ 240
608006	BAR - NEEDLE BEARING - 45LB - 28MM DIA	\$ 900
608006-99	BAR - NEEDLE BEARING - 45LB - 28MM DIA	\$ 950

DUMBBELLS - RUBBER HEX

DB-RH-10	DUMBBELL-RUBBER HEX W/CHROME ERGO HANDLE-10LB (PAIR)	\$ 34
DB-RH-100	DUMBBELL-RUBBER HEX W/CHROME ERGO HANDLE-100LB (PAIR)	\$ 341
DB-RH-105	DUMBBELL-RUBBER HEX W/CHROME ERGO HANDLE-105LB (PAIR)	\$ 358
DB-RH-110	DUMBBELL-RUBBER HEX W/CHROME ERGO HANDLE-110LB (PAIR)	\$ 375
DB-RH-115	DUMBBELL-RUBBER HEX W/CHROME ERGO HANDLE-115LB (PAIR)	\$ 392
DB-RH-12.5	DUMBBELL-RUBBER HEX W/CHROME ERGO HANDLE-12.5LB (PAIR)	\$ 56
DB-RH-120	DUMBBELL-RUBBER HEX W/CHROME ERGO HANDLE-120LB (PAIR)	\$ 409

DB-RH-125	DUMBBELL-RUBBER HEX W/CHROME ERGO HANDLE-125LB (PAIR)	\$ 426
DB-RH-130	DUMBBELL-RUBBER HEX W/CHROME ERGO HANDLE-130LB (PAIR)	\$ 443
DB-RH-140	DUMBBELL-RUBBER HEX W/CHROME ERGO HANDLE-140LB (PAIR)	\$ 477
DB-RH-15	DUMBBELL-RUBBER HEX W/CHROME ERGO HANDLE-15LB (PAIR)	\$ 51
DB-RH-150	DUMBBELL-RUBBER HEX W/CHROME ERGO HANDLE-150LB (PAIR)	\$ 511
DB-RH-2.5	DUMBBELL-RUBBER HEX W/CHROME ERGO HANDLE-2.5LB (PAIR)	\$ 11
DB-RH-20	DUMBBELL-RUBBER HEX W/CHROME ERGO HANDLE-20LB (PAIR)	\$ 68
DB-RH-25	DUMBBELL-RUBBER HEX W/CHROME ERGO HANDLE-25LB (PAIR)	\$ 85
DB-RH-30	DUMBBELL-RUBBER HEX W/CHROME ERGO HANDLE-30LB (PAIR)	\$ 102
DB-RH-35	DUMBBELL-RUBBER HEX W/CHROME ERGO HANDLE-35LB (PAIR)	\$ 119
DB-RH-40	DUMBBELL-RUBBER HEX W/CHROME ERGO HANDLE-40LB (PAIR)	\$ 136
DB-RH-45	DUMBBELL-RUBBER HEX W/CHROME ERGO HANDLE-45LB (PAIR)	\$ 153
DB-RH-5	DUMBBELL-RUBBER HEX W/CHROME ERGO HANDLE-5LB (PAIR)	\$ 17
DB-RH-50	DUMBBELL-RUBBER HEX W/CHROME ERGO HANDLE-50LB (PAIR)	\$ 170
DB-RH-55	DUMBBELL-RUBBER HEX W/CHROME ERGO HANDLE-55LB (PAIR)	\$ 187
DB-RH-60	DUMBBELL-RUBBER HEX W/CHROME ERGO HANDLE-60LB (PAIR)	\$ 204
DB-RH-65	DUMBBELL-RUBBER HEX W/CHROME ERGO HANDLE-65LB (PAIR)	\$ 221
DB-RH-70	DUMBBELL-RUBBER HEX W/CHROME ERGO HANDLE-70LB (PAIR)	\$ 238
DB-RH-75	DUMBBELL-RUBBER HEX W/CHROME ERGO HANDLE-75LB (PAIR)	\$ 256
DB-RH-80	DUMBBELL-RUBBER HEX W/CHROME ERGO HANDLE-80LB (PAIR)	\$ 273
DB-RH-85	DUMBBELL-RUBBER HEX W/CHROME ERGO HANDLE-85LB (PAIR)	\$ 290
DB-RH-90	DUMBBELL-RUBBER HEX W/CHROME ERGO HANDLE-90LB (PAIR)	\$ 307
DB-RH-95	DUMBBELL-RUBBER HEX W/CHROME ERGO HANDLE-95LB (PAIR)	\$ 324
DB-RH-SET-5-100	DUMBBELL-SET-RUBBER HEX W/CHROME ERGO HANDLE - 5-100 LBS	\$ 3,513
DB-RH-SET-5-50	DUMBBELL-SET-RUBBER HEX W/CHROME ERGO HANDLE - 5-50 LBS	\$ 906
DB-RH-SET-55-75	DUMBBELL-SET-RUBBER HEX W/CHROME ERGO HANDLE - 55-75 LBS	\$ 1,070
DB-RH-SET-80-100	DUMBBELL-SET-RUBBER HEX W/CHROME ERGO HANDLE - 80-100 LBS	\$ 1,482
KETTLEBELLS		
KB-9	9 LB-DYNAMIC KETTLEBELLS	\$ 24
KB-13	13 LB-DYNAMIC KETTLEBELLS	\$ 34
KB-18	18 LB-DYNAMIC KETTLEBELLS	\$ 45
KB-26	26 LB-DYNAMIC KETTLEBELLS	\$ 65
KB-35	35 LB-DYNAMIC KETTLEBELLS	\$ 86
KB-44	44 LB-DYNAMIC KETTLEBELLS	\$ 106
KB-53	53 LB-DYNAMIC KETTLEBELLS	\$ 127
KB-62	62 LB-DYNAMIC KETTLEBELLS	\$ 147
KB-70	70 LB-DYNAMIC KETTLEBELLS	\$ 168
KB-80	80 LB-DYNAMIC KETTLEBELLS	\$ 199
KB-88	88 LB-DYNAMIC KETTLEBELLS	\$ 209
KB-97	97 LB-DYNAMIC KETTLEBELLS	\$ 243
KB-106	106 LB-DYNAMIC KETTLEBELLS	\$ 264
TRAINING ITEMS		
600000	MEDICINE BALL 6LBS 230MM DIAMETER BLACK/GRAY W/BLACK LOGO	\$ 36
600000	MEDICINE BALL 6LBS 230MM DIAMETER BLACK/GRAY W/BLACK LOGO	\$ 36
600001	MEDICINE BALL 8LBS 230MM DIAMETER BLACK/GRAY W/BLACK LOGO	\$ 44
600002	MEDICINE BALL 10LBS 239MM DIAMETER BLACK/GRAY W/BLACK LOGO	\$ 49
600003	MEDICINE BALL 12LBS 286MM DIAMETER BLACK/GRAY W/BLACK LOGO	\$ 54
600004	MEDICINE BALL 14LBS 286MM DIAMETER BLACK/GRAY W/BLACK LOGO	\$ 59
600005	MEDICINE BALL 16LBS 286MM DIAMETER BLACK/GRAY W/BLACK LOGO	\$ 63
600006	MEDICINE BALL 18LBS 286MM DIAMETER BLACK/GRAY W/BLACK LOGO	\$ 68
600007	MEDICINE BALL 20LBS 286MM DIAMETER BLACK/GRAY W/BLACK LOGO	\$ 85
600008	MEDICINE BALL 25LBS 286MM DIAMETER BLACK/GRAY W/BLACK LOGO	\$ 141
600009	MEDICINE BALL 30LBS 286MM DIAMETER BLACK/GRAY W/BLACK LOGO	\$ 202
600400	SLAM BALL 14IN DIAMETER 10LBS	\$ 17
600401	SLAM BALL 14IN DIAMETER 15LBS	\$ 20
600402	SLAM BALL 14IN DIAMETER 20LBS	\$ 25
600403	SLAM BALL 14IN DIAMETER 25LBS	\$ 41
600404	SLAM BALL 14IN DIAMETER 30LBS	\$ 46
600405	SLAM BALL 14IN DIAMETER 35LBS	\$ 51
600406	SLAM BALL 14IN DIAMETER 40LBS	\$ 56
600407	SLAM BALL 14IN DIAMETER 45LBS	\$ 61
600408	SLAM BALL 14IN DIAMETER 50LBS	\$ 66
600800	WALL BALL 6LB 35CM BLACK/GRAY W/BLACK PRINT	\$ 60
600801	WALL BALL 8LB 35CM BLACK/GRAY W/BLACK PRINT	\$ 61
600802	WALL BALL 10LB 35CM BLACK/GRAY W/BLACK PRINT	\$ 63
600803	WALL BALL 12LB 35CM BLACK/GRAY W/BLACK PRINT	\$ 64
600804	WALL BALL 14LB 35CM BLACK/GRAY W/BLACK PRINT	\$ 65
600805	WALL BALL 16LB 35CM BLACK/GRAY W/BLACK PRINT	\$ 67
600806	WALL BALL 18LB 35CM BLACK/GRAY W/BLACK PRINT	\$ 68
600807	WALL BALL 20LB 35CM BLACK/GRAY W/BLACK PRINT	\$ 69
600808	WALL BALL 25LB 35CM BLACK/GRAY W/BLACK PRINT	\$ 74
600809	WALL BALL 30LB 35CM BLACK/GRAY W/BLACK PRINT	\$ 78
600950	PHYSIO (ANTI-BURST) BALL 55CM - BLACK W/WHITE LOGO	\$ 11
600951	PHYSIO (ANTI-BURST) BALL 65CM - BLACK W/WHITE LOGO	\$ 13

600952	PHYSIO (ANTI-BURST) BALL 75CM - BLACK W/WHITE LOGO	\$ 16
606000	3-1 WOOD PLYO BOX	\$ 149
609001	BATTLE ROPE 1.5IN DIA 30FT LONG	\$ 100
609002	BATTLE ROPE 1.5IN DIA 40FT LONG	\$ 133
609003	BATTLE ROPE 1.5IN DIA 50FT LONG	\$ 161
609100	BATTLE ROPE 2IN DIA 30FT LONG	\$ 159
609101	BATTLE ROPE 2IN DIA 40FT LONG	\$ 210
609102	BATTLE ROPE 2IN DIA 50FT LONG	\$ 260
610000	AGILITY LADDER - BLACK/YELLOW 30FT	\$ 44
610001	AGILITY CONE 9"	\$ 44
610500	GYM RING - WOOD HANDLE	\$ 130
610501	GYM RING - PLASTIC HANDLE	\$ 55
611000	LACROSSE BALL BLACK WITH WHITE LOGO	\$ 6
612000	XX-LIGHT RESISTANCE BAND RED 41IN LONG 3/8IN THICK 1/2IN WIDE	\$ 11
612001	X-LIGHT RESISTANCE BAND BLACK 41IN LONG 3/8IN THICK 13/16IN WIDE	\$ 17
612002	LIGHT RESISTANCE BAND PURPLE 41IN LONG 3/8IN THICK 1-1/8IN WIDE	\$ 25
612003	MEDIUM RESISTANCE BAND GREEN 41IN LONG 3/8IN THICK 1-3/4IN WIDE	\$ 35
612004	HEAVY RESISTANCE BAND BLUE 41IN LONG 3/8IN THICK 2-1/2IN WIDE	\$ 48
612005	X-HEAVY RESISTANCE BAND ORANGE 41IN LONG 3/8IN THICK 3-1/4IN WIDE	\$ 62
612006	XX-HEAVY RESISTANCE BAND GRAY 41IN LONG 3/8IN THICK 4IN WIDE	\$ 77
613000	BLACK ABDOMINAL EXERCISER W/ GRAY DYNAMIC LOGO	\$ 17
613500	FOAM ROLLER - EXTRA FIRM - 12IN LENGTH - BLACK	\$ 10
613501	FOAM ROLLER - FIRM - 12IN LENGTH - BLACK	\$ 14
613502	FOAM ROLLER - EXTRA FIRM - 36IN LENGTH - BLACK	\$ 26
613503	FOAM ROLLER - FIRM - 36IN LENGTH - BLACK	\$ 30
613600	CLUB MAT 72IN X 24IN X .625IN BLACK	\$ 33
LIFTING ACCESSORIES		
611500	BAR CLAMP SPRING STYLE STRAIGHT HANDLES - WITH LOGO (PAIR)	\$ 5
611501	BAR CLAMP SPRING STYLE 90 DEGREE BENT HANDLES WITH LOGO (PAIR)	\$ 5
613650	30LB LIFTING CHAIN SET (PAIR)	\$ 92
613651	45LB LIFTING CHAIN SET (PAIR)	\$ 129
613652	60LB LIFTING CHAIN SET (PAIR)	\$ 177
620500	BIG GRIP PADDED LIFTING STRAPS - BLACK	\$ 26
620600	BIG GRIP LIFTING STRAPS - BLACK	\$ 19
621300	BLACK PADDED COTTON LIFTING STRAPS - 21IN	\$ 16
621501	BLACK COTTON LIFTING STRAPS - 20.5IN	\$ 12
628410	BLACK 4IN PADDED LEATHER BELT - SMALL	\$ 38
628420	BLACK 4IN PADDED LEATHER BELT - MEDIUM	\$ 38
628430	BLACK 4IN PADDED LEATHER BELT - LARGE	\$ 38
628440	BLACK 4IN PADDED LEATHER BELT - XLARGE	\$ 38
628510	BLACK 6" PADDED LEATHER BELT - SMALL	\$ 47
628520	BLACK 6" PADDED LEATHER BELT - MEDIUM	\$ 47
628530	BLACK 6" PADDED LEATHER BELT - LARGE	\$ 47
628540	BLACK 6" PADDED LEATHER BELT - XLARGE	\$ 47
628550	BLACK 6IN PADDED LEATHER BELT - XXLARGE	\$ 47
628800	LEATHER DIP BELT - BLACK	\$ 67
628900	POLYPROPYLENE DIP BELT	\$ 50
629000	16IN OLYMPIC BAR PAD - BLACK	\$ 25

LEGACY TITAN - PRE-2019		MSRP
Model #	Item Description	PRICING
RACKS		
400001	TITAN POWER RACK (RIG STYLE 30 DEPTH) - W/ J-CUPS PIN/PIPE SAFETY BARS TWO SINGLE PULL UP BARS	\$ 2,202.69
400002	TITAN SQUAT RACK - W/J-CUPS SINGLE PULL UP BAR 1.25	\$ 1,192.00
400005	TITAN POWER RACK - W/J-CUPS PIN/PIPE SAFETY BARS TWO SINGLE PULL UP BARS 1.25	\$ 2,651.90
400012	TITAN HALF RACK W/STORAGE - W/J-CUPS 8 LONG PLATE STORAGE PEGS SAFETY ARMS TWO SINGLE PULL UP BAR	\$ 2,614.00
400014	TITAN POWER RACK W/STORAGE - W/J-CUPS 8 LONG PLATE STORAGE PEGS PIN/PIPE SAFETY BARS TWO SINGLE	\$ 3,612.00
400016	TITAN DOUBLE HALF RACK - W/J-CUPS SAFETY ARMS 8 LONG PLATE STORAGE PEGS TWO SINGLE PULL UP BARS	\$ 3,838.00
400017	TITAN POWER RACK/HALF RACK COMO 8'	\$ 6,136.00
400018	TITAN RACK- HALF 3INX3IN (J-CUPS STORAGE&SAFETY ARMS) - 7FT UPRIGHTS	\$ 2,569.41
400090	TITAN FOLDING WALL MOUNT RACK 20 DEPTH - DOES NOT INCLUDE WALL MOUNTING HARDWARE	\$ 1,268.86
400091	TITAN FOLDING WALL MOUNT RACK 43 DEPTH - DOES NOT INCLUDE WALL MOUNTING HARDWARE	\$ 1,420.17
RACK ATTACHMENTS		
409007	TITAN J-CUPS (PAIR)	\$ 120
409008	TITAN SAFETY ARMS (PAIR) (FITS RIGS/HALF RACKS/DOUBLE RACKS)	\$ 240
409042	TITAN SAFETY BARS XD 30 LENGTH (PAIR) - FITS 3/4 & POWER RACKS	\$ 398
409043	TITAN SAFETY RODS STANDARD 30 LENGTH (PAIR) - FITS 3/4 & POWER RACKS	\$ 329
409045	TITAN SPOTTER PLATFORMS FOLDING (PAIR) (NOT COMPATIBLE W/400001 RIG STYLE POWER RACK)	\$ 324
409010	TITAN LANDMINE SINGLE KNUCKLE	\$ 112
409011	TITAN BAND PEGS (PAIR)	\$ 62
409012	TITAN PLATE STORAGE PEG - 12IN LONG	\$ 60
409012-8PK	TITAN PLATE STORAGE PEGS - LONG 8-PACK	\$ 480
409013	TITAN BALL TARGET 16 (LOGO OPTION AVAILABLE SEE SALES)	\$ 146
409013-LOGO	DYNAMIC LOGO BALL TARGET	\$ 174

409104	TITAN HANGING BAR STORAGE SINGLE	\$ 42
409029	TITAN PULL-UP BALL W/HARDWARE (REQUIRES XD CROSSMEMBER SEE SALES)	\$ 70
409103	TITAN ATTACHMENT - PULL-UP BALL 7IN	\$ 58
409198	MULTI BALL GRIP PULL-UP ATTACHMENT	\$ 473
409030	TITAN CHIN-UP BAR (REQUIRES XD CROSSMEMBER SEE SALES)	\$ 142
409031	TITAN FRAME MOUNT SINGLE BAR STORAGE W/HARDWARE	\$ 58
409040	TITAN LANDMINE DOUBLE KNUCKLE	\$ 226
409048	TITAN XMEMBER - PULL-UP BAR SINGLE 2 TOUGH 4 WIDTH	\$ 155
409049	TITAN XMEMBER - PULL-UP BAR SINGLE 2 TOUGH 6 WIDTH	\$ 215
409082	TITAN JAMMER ARMS	\$ 569
409093	TITAN D-RING ROPE ANCHOR	\$ 141
409194	TITAN SINGLE ROLLER PAD	\$ 311
409130	TITAN QUICK-CHANGE DIP STATION	\$ 282
409131	TITAN QUICK-CHANGE PLYO STEP	\$ 294
411000-200A	200LB 2:1 PULLEY RATIO WEIGHT STACK - SEE SALES FOR COMPATIBILITY	\$ 2,990
411000-300A	300LB 2:1 PULLEY RATIO WEIGHT STACK - SEE SALES FOR COMPATIBILITY	\$ 3,324
CLASSIC RACK CONNECTORS		<i>Mating bolt versions available</i>
409102	TITAN 71IN SINGLE BAR XMEMBER	\$ 233
409002	TITAN XMEMBER - SINGLE BAR 7IN WIDTH SOLID	\$ 216
409004	TITAN XMEMBER - DOUBLE BAR 70IN WIDTH SINGLE WALL	\$ 265
409004-LOGO	TITAN XMEMBER - DOUBLE BAR 70IN WIDTH SINGLE WALL W/LASER-CUT LOGO	\$ 452
409059	STORAGE - XMEMBER - SINGLE 60IN	\$ 180
409106	TITAN 95IN SINGLE BAR XMEMBER	\$ 277
409108	TITAN 95IN DOUBLE BAR	\$ 416
409109	TITAN 95IN SINGLE PULL UP BAR	\$ 332

DYNAMIC TITAN RIGS		MSRP
MODEL#	ITEM DESCRIPTION	PRICING
TITAN RIG PACKAGES		
	<i>SEE SALES FOR CUSTOMIZED RIG OPTIONS</i>	
400026	CORNER TRAINING UNIT - 120IN WIDE X 112IN DEEP X 123IN TALL	\$ 6,654
400026A	CORNER TRAINING UNIT W/ACCESSORIES	\$ 8,938
T-6CR001	CUSTOM 6FT MONKEY BAR RIG	\$ 4,974
T-6CR001-A	CUSTOM 6FT MONKEY BAR RIG W/ ACCESSORIES	\$ 7,742
T-14CR002	CUSTOM 14FT MONKEY BAR RIG	\$ 8,190
T-14CR002-A	CUSTOM 14FT MONKEY BAR RIG W/ ACCESSORIES	\$ 12,142
T-14CR0038	CUSTOM 14FT RIG WITH 2FT EXTENSION	\$ 11,348
T-14CR0038-A	CUSTOM 14FT RIG WITH 2 FT EXTENSION WITH ACCESSORIES	\$ 16,620
T-4CR003	CUSTOM 4FT MONKEY BAR RIG	\$ 3,058
T-4CR003-A	CUSTOM 4FT PERSONAL MONKEY BAR RIG W/ ACCESSORIES	\$ 5,618
T-14CR007	CUSTOM 14FT PREMIUM "X" RIG	\$ 14,762
T-14CR007-A	CUSTOM 14FT PREMIUM "X" RIG W/ ACCESSORIES	\$ 19,196
T-20CR002	CUSTOM 20FT INCLINE MONKEY BAR RIG	\$ 12,534
T-20CR002-A	CUSTOM 20FT INCLINE MONKEY BAR RIG WITH ACCESSORIES	\$ 20,040
T-CR-10W6D	10FT SELF SUPPORTED RIG	\$ 4,312
T-CR-10W6D-A	10FT SELF SUPPORTED RIG W/ ACCESSORIES	\$ 7,088
T-CR-14W6D	14FT SELF SUPPORTED RIG	\$ 5,664
T-CR-14W6D-A	14FT SELF SUPPORTED RIG W/ ACCESSORIES	\$ 9,882
T-M3ZONE3.0	TITAN - M3ZONE3.0 GROUP TRAINER	\$ 5,526
T-M3ZONE3.0-A	TITAN - M3ZONE 3.0 GROUP TRAINER WITH ACCESSORIES	\$ 8,294
T-M3ZONE4.0	TITAN - M3ZONE4.0 GROUP TRAINER	\$ 10,762
T-M3ZONE4.0-A	TITAN - M3ZONE4.0 GROUP TRAINER WITH ACCESSORIES	\$ 15,030
T-MR-10W4D	T-MR-10W4D SELF-SUPPORTED (3INX3IN TUBE)	\$ 3,206
T-MR-10W6D	T-MR-10W6D SELF-SUPPORTED (3INX3IN TUBE)	\$ 3,372
T-MR-14W4D	T-MR-14W4D SELF-SUPPORTED (3INX3IN TUBE)	\$ 4,422
T-MR-14W6D	T-MR-14W6D SELF-SUPPORTED (3INX3IN TUBE)	\$ 4,644
T-MR-20W4D	T-MR-20W4D SELF-SUPPORTED (3INX3IN TUBE)	\$ 5,672
T-MR-20W6D	T-MR-20W6D SELF-SUPPORTED (3INX3IN TUBE)	\$ 5,950
T-MR-24W4D	T-MR-24W4D SELF-SUPPORTED (3INX3IN TUBE)	\$ 6,888
T-MR-24W6D	T-MR-24W6D SELF-SUPPORTED (3INX3IN TUBE)	\$ 7,220
T-WMR-10W4D	T-WMR-10W4D WALL-MOUNTED (3INX3IN TUBE)	\$ 1,996
T-WMR-10W6D	T-WMR-10W6D WALL-MOUNTED (3INX3IN TUBE)	\$ 2,162
T-WMR-14W4D	T-WMR-14W4D WALL-MOUNTED (3INX3IN TUBE)	\$ 2,762
T-WMR-14W6D	T-WMR-14W6D WALL-MOUNTED (3INX3IN TUBE)	\$ 2,982
T-WMR-20W4D	T-WMR-20W4D WALL-MOUNTED (3INX3IN TUBE)	\$ 3,506
T-WMR-20W6D	T-WMR-20W6D WALL-MOUNTED (3INX3IN TUBE)	\$ 3,782
T-WMR-24W4D	T-WMR-24W4D WALL-MOUNTED (3INX3IN TUBE)	\$ 4,270
T-WMR-24W6D	T-WMR-24W6D WALL-MOUNTED (3INX3IN TUBE)	\$ 4,602
BASIC RIG COMPONENTS		
	<i>SEE SALES FOR CUSTOMIZED RIG OPTIONS</i>	
409001	TITAN XMEMBER - SINGLE BAR 4 WIDTH SINGLE WALL	\$ 137
409002	TITAN XMEMBER - SINGLE BAR 7IN WIDTH SOLID	\$ 216
409003	TITAN XMEMBER - DOUBLE BAR 4 WIDTH SINGLE WALL	\$ 208
409003-LOGO	TITAN XMEMBER - DOUBLE BAR 4 WIDTH SINGLE WALL W/LASER-CUT LOGO	\$ 256
409004	TITAN XMEMBER - DOUBLE BAR 70IN WIDTH SINGLE WALL	\$ 265
409004-LOGO	TITAN XMEMBER - DOUBLE BAR 70IN WIDTH SINGLE WALL W/LASER-CUT LOGO	\$ 452

409005	TITAN XMEMBER - XD DOUBLE 6 WIDTH	\$ 317
409005-LOGO	TITAN XMEMBER - XD DOUBLE W/LASER-CUT LOGO 6 WIDTH	\$ 437
409005BP-LOGO	TITAN XMEMBER W/LOGO - XD DOUBLE 6FT WITH LOGO	\$ 591
409006	TITAN XMEMBER - TRI BAR PULL-UP 6 WIDTH SINGLE WALL	\$ 398
409014	TITAN XMEMBER - XD SINGLE 6 LENGTH	\$ 255
409015	TITAN 3X3 UPRIGHT - 7 6 TALL	\$ 250
409016	TITAN 3X3 UPRIGHT - 8 4 TALL	\$ 266
409017	TITAN 3X3 UPRIGHT - 9 TALL	\$ 278
409018	TITAN 3X3 UPRIGHT - 12 TALL	\$ 421
409190	TITAN UPRIGHT - 8'	\$ 276
409122	TITAN RIG UPRIGHT 9FT - MATCHING HOLES ON ALL SIDES	\$ 288
409019	TITAN XMEMBER - XD SINGLE 4 LENGTH	\$ 175
409020	TITAN XMEMBER - XD DOUBLE 4 WIDTH	\$ 243
409021	TITAN XMEMBER - TRI BAR PULL-UP 4 WIDTH SINGLE WALL	\$ 280
409024	TITAN XMEMBER - MONKEY BAR SINGLE 4 WIDTH	\$ 140
409025	TITAN XMEMBER - MONKEY BAR SINGLE SOLID 6 WIDTH	\$ 195
409026	TITAN XMEMBER - XD DOUBLE INCLINE 4 WIDTH	\$ 319
409027	TITAN XMEMBER - XD DOUBLE INCLINE 6 WIDTH	\$ 393
409036	TITAN MULTIGRIP CROSSBAR 4FT WIDTH	\$ 236
409118	TITAN XMEMBER - XD SINGLE 10IN EXTENDER	\$ 107
409069	TITAN XMEMBER - XD SINGLE 20 WIDTH	\$ 127
409038	TITAN XMEMBER - XD SINGLE 24IN WIDTH	\$ 139
409041	TITAN XMEMBER - SINGLE BAR 6 WIDTH SINGLE WALL	\$ 221
409080	BAR - 43" XD SINGLE - 90 DEGREE HOLES	\$ 168
409106	TITAN 95IN SINGLE BAR XMEMBER	\$ 277
409108	TITAN 95IN DOUBLE BAR	\$ 416
409109	TITAN 95IN SINGLE PULL UP BAR	\$ 332
409136	TITAN ACCESSORY HOOK CROSSBAR 24 - (ACCESSORY HOOKS NOT INCLUDED)	\$ 140
409137	TITAN ACCESSORY HOOK CROSSBAR 43 - (ACCESSORY HOOKS NOT INCLUDED)	\$ 150
RIG ATTACHMENTS		
409007	TITAN J-CUPS (PAIR)	\$ 120
409008	TITAN SAFETY ARMS (PAIR) (FITS RIGS/HALF RACKS/DOUBLE RACKS)	\$ 240
409010	TITAN LANDMINE SINGLE KNUCKLE	\$ 112
409011	TITAN BAND PEGS (PAIR)	\$ 62
409012	TITAN PLATE STORAGE PEG - 12IN LONG	\$ 60
409012-8PK	TITAN PLATE STORAGE PEGS - LONG 8-PACK	\$ 480
409013	TITAN BALL TARGET 16 (LOGO OPTION AVAILABLE SEE SALES)	\$ 146
409013-LOGO	DYNAMIC LOGO BALL TARGET	\$ 174
409022	TITAN SKID PLATE - 4 LENGTH - RIGS ONLY	\$ 365
409023	TITAN SKID PLATE - 6 LENGTH - RIGS ONLY	\$ 392
409024	TITAN XMEMBER - MONKEY BAR SINGLE 4 WIDTH	\$ 140
409025	TITAN XMEMBER - MONKEY BAR SINGLE SOLID 6 WIDTH	\$ 195
409028	TITAN D-HANDLE / ROPE ANCHOR W/HARDWARE	\$ 67
409029	TITAN PULL-UP BALL W/HARDWARE (REQUIRES XD CROSSMEMBER SEE SALES)	\$ 70
409103	TITAN ATTACHMENT - PULL-UP BALL 7IN	\$ 58
409198	MULTI BALL GRIP PULL-UP ATTACHMENT	\$ 473
409030	TITAN CHIN-UP BAR (REQUIRES XD CROSSMEMBER SEE SALES)	\$ 142
409031	TITAN FRAME MOUNT SINGLE BAR STORAGE W/HARDWARE	\$ 58
409032A	TITAN ATTACHMENT - FRAME MOUNT ACCESSORY SHACKLE W/CARABINER	\$ 130
409033	TITAN FLYING PULL UP 4 WIDTH	\$ 915
409035	TITAN FLYING PULL UP 6FT WIDTH	\$ 1,006
409039	TITAN CANTILEVER ARM - (ACCESSORY SHACKLE 409032 NOT INCLUDED)	\$ 252
409040	TITAN LANDMINE DOUBLE KNUCKLE	\$ 226
409044	TITAN XMEMBER - MONKEY BAR SINGLE 6 WIDTH	\$ 163
409048	TITAN XMEMBER - PULL-UP BAR SINGLE 2 TOUGH 4 WIDTH	\$ 155
409049	TITAN XMEMBER - PULL-UP BAR SINGLE 2 TOUGH 6 WIDTH	\$ 215
409066	TITAN BALL TARGET 22IN (LOGO OPTION AVAILABLE SEE SALES)	\$ 196
409066-LOGO	TITAN BALL TARGET 22IN DIAMETER W/LOGO	\$ 213
409071	TITAN GLUTE HAM DEVELOPER SPLIT PAD	\$ 1,913
409082	TITAN JAMMER ARMS	\$ 569
409093	TITAN D-RING ROPE ANCHOR	\$ 141
409194	TITAN SINGLE ROLLER PAD	\$ 311
409097	TITAN 43IN DROP-IN SHELF - CONNECTS TO XD SINGLE 2' OR 4'	\$ 216
409098	TITAN 70IN DROP-IN SHELF- CONNECTS TO XD SINGLE 2' OR 4'	\$ 411
409152	TITAN 43" BOSU STORAGE	\$ 277
409139	TITAN 70IN/71IN ANNEX BOSU BALL STORAGE	\$ 430
409141	STORAGE TRAY - SMALL - FITS ON XD SINGLE	\$ 117
409130	TITAN QUICK-CHANGE DIP STATION	\$ 282
409131	TITAN QUICK-CHANGE PLYO STEP	\$ 294
409135	6IN ACCESSORY HOOK	\$ 25
409138	10IN ACCESSORY HOOK	\$ 29
409147	6IN ACCESSORY HOOK (FITS ON XD SINGLE BARS - 3IN X 3IN)	\$ 29
409148	10IN ACCESSORY HOOK (FITS ON XD SINGLE BARS -3IN X 3IN)	\$ 29
411000-200A	200LB 2:1 PULLEY RATIO WEIGHT STACK	\$ 2,990

411000-300A	300LB 2:1 PULLEY RATIO WEIGHT STACK	\$ 3,324
409050	LEGACY - TITAN ANNEX STORAGE - SINGLE END UPRIGHT 51 HEIGHT	\$ 235
POWER POST		
409133	POWER POST SHORT - ATTACHMENT STORAGE OR SHORT WALL TRAINER 3 X3 X72(MOUNTING HARDWARE EXCLUDED)	\$ 314
409132	POWER POST TALL - TALL WALL TRAINER OR ATTACHMENT STORAGE 3 X3 X108(MOUNTING HARDWARE EXCLUDED)	\$ 418
409126	POWER POST ATTACHMENT - CHIN UP BAR W/ LOCK PIN	\$ 314
409127	POWER POST ATTACHMENT - 16 BALL TARGET ADJUSTABLE W/ LOCK PINS	\$ 277
409128	POWER POST ATTACHMENT - CANTILEVER ARM ADJUSTABLE W/ LOCK PINS	\$ 346
409129	POWER POST ATTACHMENT - D-HANDLE / ROPE ANCHOR ADJUSTABLE W/ LOCK PIN	\$ 175
STORAGE UNITS - CUSTOMIZABLE		
400020	ARSENAL STORAGE UNIT - SAFE 10 WIDTH	\$ 5,819
400021	ARSENAL SAFE 10FT STORAGE UNIT W/MATING BOLT - ACCESSORIES NOT INCLUDED	\$ 6,109
400022	ARSENAL STORAGE UNIT - LOCKER 6 WIDTH	\$ 3,849
400023	ARSENAL LOCKER 6FT STORAGE UNIT W/MATING BOLT - ACCESSORIES NOT INCLUDED	\$ 4,090
400024	ARSENAL STORAGE UNIT - VAULT 16 WIDTH	\$ 7,487

LEGACY GLADIATOR - PRE-2019		MSRP
Model #	Item Description	PRICING
GLADIATOR RIGS		
<i>See sales for customization options</i>		
G-MR-10W6D	G-MR-10W6D SELF-SUPPORTED (2INX3IN TUBE)	\$ 2,785
G-MR-14W6D	G-MR-14W6D SELF-SUPPORTED (2INX3IN TUBE)	\$ 3,832
G-MR-20W6D	G-MR-20W6D SELF-SUPPORTED (2INX3IN TUBE)	\$ 4,920
G-MR-24W6D	G-MR-24W6D SELF-SUPPORTED (2INX3IN TUBE)	\$ 5,967
G-MR-34W6D	G-MR-34W6D SELF-SUPPORTED (2INX3IN TUBE)	\$ 8,102
G-WMR-14W4D	G-WMR-14W4D WALL-MOUNTED (2INX3IN TUBE)	\$ 2,227
G-MR-10W4D	G-MR-10W4D SELF-SUPPORTED (2INX3IN TUBE)	\$ 2,656
G-MR-14W4D	G-MR-14W4D SELF-SUPPORTED (2INX3IN TUBE)	\$ 3,660
G-MR-20W4D	G-MR-20W4D SELF-SUPPORTED (2INX3IN TUBE)	\$ 4,705
G-MR-24W2D	G-MR-24W2D SELF-SUPPORTED (2INX3IN TUBE)	\$ 5,274
G-MR-24W4D	G-MR-24W4D SELF-SUPPORTED (2INX3IN TUBE)	\$ 5,709
G-MR-30W4D	G-MR-30W4D SELF-SUPPORTED (2INX3IN TUBE)	\$ 6,754
G-MR-30W6D	G-MR-30W6D SELF-SUPPORTED (2INX3IN TUBE)	\$ 7,055
G-WMR-10W4D	G-WMR-10W4D WALL-MOUNTED (2INX3IN TUBE)	\$ 1,615
G-WMR-10W6D	G-WMR-10W6D WALL-MOUNTED (2INX3IN TUBE)	\$ 1,744
G-WMR-14W6D	G-WMR-14W6D WALL-MOUNTED (2INX3IN TUBE)	\$ 2,399
G-WMR-20W4D	G-WMR-20W4D WALL-MOUNTED (2INX3IN TUBE)	\$ 2,838
G-WMR-20W6D	G-WMR-20W6D WALL-MOUNTED (2INX3IN TUBE)	\$ 3,053
G-WMR-24W4D	G-WMR-24W4D WALL-MOUNTED (2INX3IN TUBE)	\$ 3,450
G-WMR-24W6D	G-WMR-24W6D WALL-MOUNTED (2INX3IN TUBE)	\$ 3,708
GLADIATOR RACK ATTACHMENTS		
309007	GLADIATOR J-CUPS (PAIR)	\$ 93
309008	GLADIATOR SAFETY ARMS SET (FITS HALF RACK/DOUBLE RACK)	\$ 150
309009	GLADIATOR DIP STATION	\$ 260
309010	GLADIATOR LANDMINE SINGLE	\$ 99
309011	GLADIATOR BAND PEGS (PAIR)	\$ 48
309012S	GLADIATOR SHORT PLATE STORAGE PEG 8IN	\$ 54
309013	GLADIATOR ATTACHMENT-BALL TARGET-16IN - BLANK NO LOGO	\$ 137
309028	GLADIATOR D-HANDLE	\$ 57
309030	GLADIATOR ATTACHMENT - CHIN-UP BAR - FOR RIGS OR RACKS	\$ 134
309031	GLADIATOR FRAME MOUNT SINGLE BAR STORAGE	\$ 44
309034	GLADIATOR ATTACHMENT - PLYO	\$ 243
309042	GLADIATOR XD SAFETY BAR SET - 30 (FITS 3/4 & POWER RACKS)	\$ 380
309043	GLADIATOR PIN/PIPE SAFETY BARS SET - 30 (FITS 3/4 & POWER RACKS)	\$ 288

DYNAMIC PLATFORM LINE-LEGACY		MSRP
MODEL#		PRICING
TITAN PLATFORMS		
TITANHR-483-PI-LOGO	TITAN HALF RACK 4 X 8 X 3 PLATFORM W/ INSERT KIT W/ LOGO	\$ 2,892
TITANHR-483-PI	TITAN HALF RACK 4 X 8 X 3 PLATFORM W/ INSERT KIT	\$ 2,592
TITANHR-683-PI-LOGO	TITAN HALF RACK 6 X 8 X 3 PLATFORM W/ INSERT KIT W/ LOGO	\$ 2,856
TITANHR-683-PI	TITAN HALF RACK 6FT X 8FT X 3IN PLATFORM W/INSERT KIT	\$ 2,556
EDGE PLATFORMS		
EDGEHR-483-PI-LOGO	EDGE HALF RACK 4 X 8 X 3 PLATFORM W/ INSERT KIT W/ LOGO	\$ 2,892
EDGEHR-483-PI	EDGE HALF RACK 4 X 8 X 3 PLATFORM W/ INSERT KIT	\$ 2,592
EDGEHR-683-PI-LOGO	EDGE HALF RACK 6 X 8 X 3 PLATFORM W/ INSERT KIT W/ LOGO	\$ 2,856
EDGEHR-683-PI	EDGE HALF RACK 6 X 8 X 3 PLATFORM W/ INSERT KIT	\$ 2,556
EDGEPR-483-PI-LOGO	EDGE POWER RACK 4 X 8 X 3 PLATFORM W/ INSERT KIT W/ LOGO	\$ 3,006
EDGEPR-483-PI	EDGE POWER RACK 4 X 8 X 3 PLATFORM W/ INSERT KIT	\$ 2,706
EDGEPR-683-PI-LOGO	EDGE POWER RACK 6 X 8 X 3 PLATFORM W/ INSERT KIT W/ LOGO	\$ 3,292
EDGEPR-683-PI	EDGE POWER RACK 6 X 8 X 3 PLATFORM W/ INSERT KIT	\$ 2,992

DYNAMIC PLATFORM LINE 2019		MSRP
MODEL#	ACCELL PLATFORMS	PRICING
PLTFM-RAMP	PLATFORM RAMP ATTACHMENT	\$ 163

PLTSA-483-LOGO	ACCELL STAND ALONE 4 X 8 X 3 PLATFORM W/ URETHANE LOGO	\$ 2,240
PLTSA-483	ACCELL STAND ALONE 4 X 8 X 3 PLATFORM	\$ 1,940
PLTSA-683-LOGO	ACCELL STAND ALONE 6 X 8 X 3 PLATFORM W/ URETHANE LOGO	\$ 2,600
PLTSA-683	ACCELL STAND ALONE 6 X 8 X 3 PLATFORM	\$ 2,300

MODEL#	ULTRA PRO & TITAN G2 PLATFORMS	MSRP PRICING
PLTFM-HR4-LOGO	HALF RACK 4 X 8 X 3 PLATFORM W/ INSERT KIT W/ LOGO	\$ 2,892
PLTFM-HR4	HALF RACK 4 X 8 X 3 PLATFORM W/ INSERT KIT	\$ 2,592
PLTFM-HR6-LOGO	HALF RACK 6 X 8 X 3 PLATFORM W/ INSERT KIT W/ LOGO	\$ 2,856
PLTFM-HR6	HALF RACK 6 X 8 X 3 PLATFORM W/ INSERT KIT	\$ 2,556
PLTFM-DHR4-LOGO	HALF RACK 4 X 8 X 3 PLATFORM W/ INSERT KIT W/ LOGO	\$ 2,892
PLTFM-DHR4	HALF RACK 4 X 8 X 3 PLATFORM W/ INSERT KIT	\$ 2,592
PLTFM-DHR6-LOGO	HALF RACK 6 X 8 X 3 PLATFORM W/ INSERT KIT W/ LOGO	\$ 2,856
PLTFM-DHR6	HALF RACK 6 X 8 X 3 PLATFORM W/ INSERT KIT	\$ 2,556
PLTFM-PR4-LOGO	POWER RACK 4 X 8 X 3 PLATFORM W/ INSERT KIT W/ LOGO	\$ 3,006
PLTFM-PR4	POWER RACK 4 X 8 X 3 PLATFORM W/ INSERT KIT	\$ 2,706
PLTFM-PR6-LOGO	POWER RACK 6 X 8 X 3 PLATFORM W/ INSERT KIT W/ LOGO	\$ 3,292
PLTFM-PR6	POWER RACK 6 X 8 X 3 PLATFORM W/ INSERT KIT	\$ 2,992



ecore™

ATHLETIC



ecoreathletic.com



INSIDE

THE

WORLD

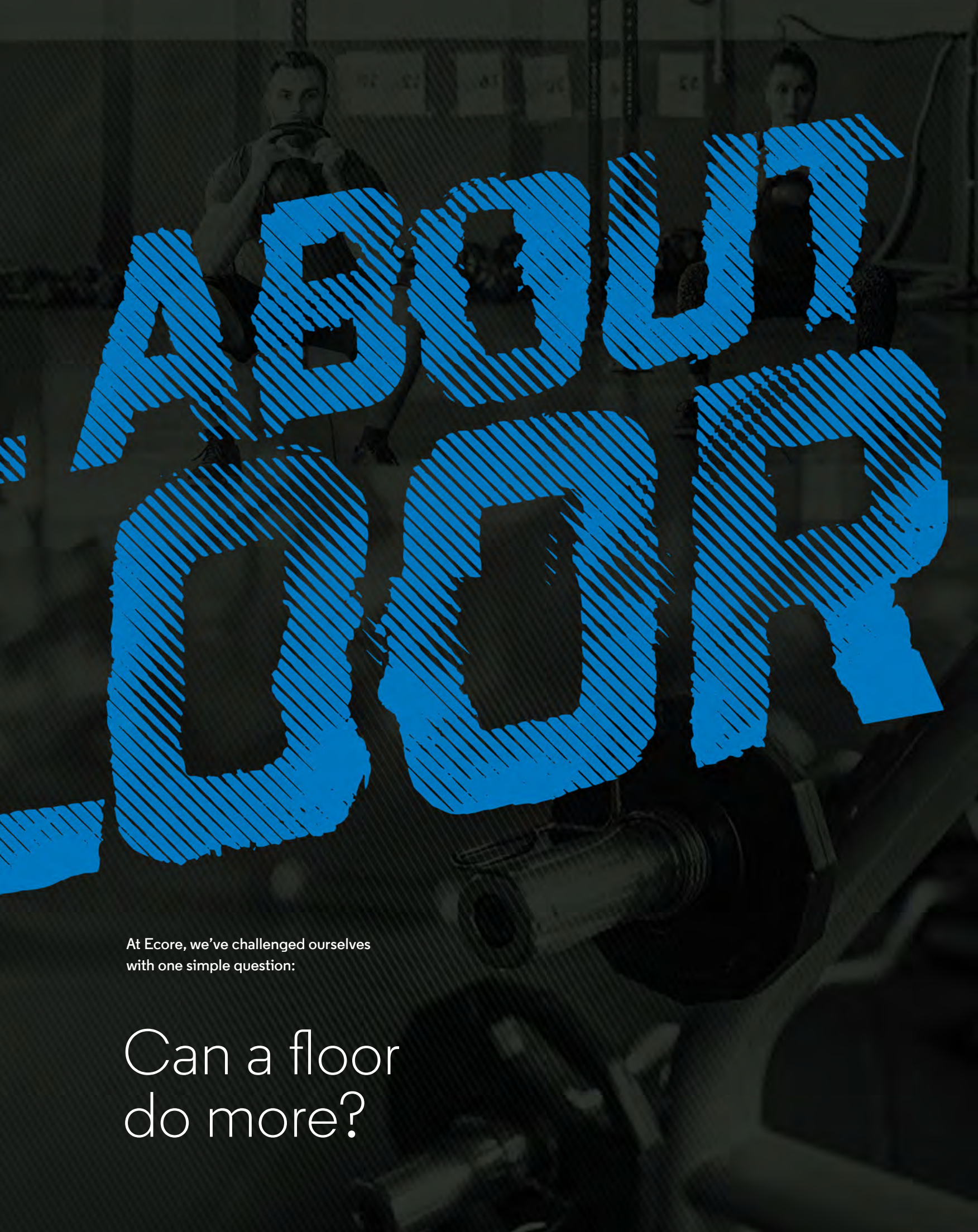

At Ecore, we've challenged ourselves
with one simple question:

Can a floor
do more?

Yes.

We believe that a floor is more than just a passive surface. It must work with the human body to provide support and sustain the ability for individuals to do what they love—longer. Your flooring should go beyond your expectations; it should benefit those who interact with it. At Ecore, we engineer performance well beyond industry standards and, through technology and innovation, are driven to provide solutions for challenges that real people face every day. Our goal is to not just provide flooring, but to provide flooring solutions that improve the lives of people across every segment of the population in every life.

ecore™ | Built by Yes.





A person is lifting a barbell with a 20kg weight plate in a gym. The background is dark with a grid pattern. The barbell is silver and the weight plate is black with '20 KG' written on it. The person's hands are visible, gripping the barbell.

To understand our company,
you have to embrace the idea that

Yes is More.

Ecore is dedicated to fully understanding the relationship between people and the surfaces they work, play and live on—and how we can contribute MORE. Safety, ergonomics, and acoustics are our core areas of opportunity to create dynamic surfaces that are catered to the individual and the specific application.

ecore™ | Built by Yes.

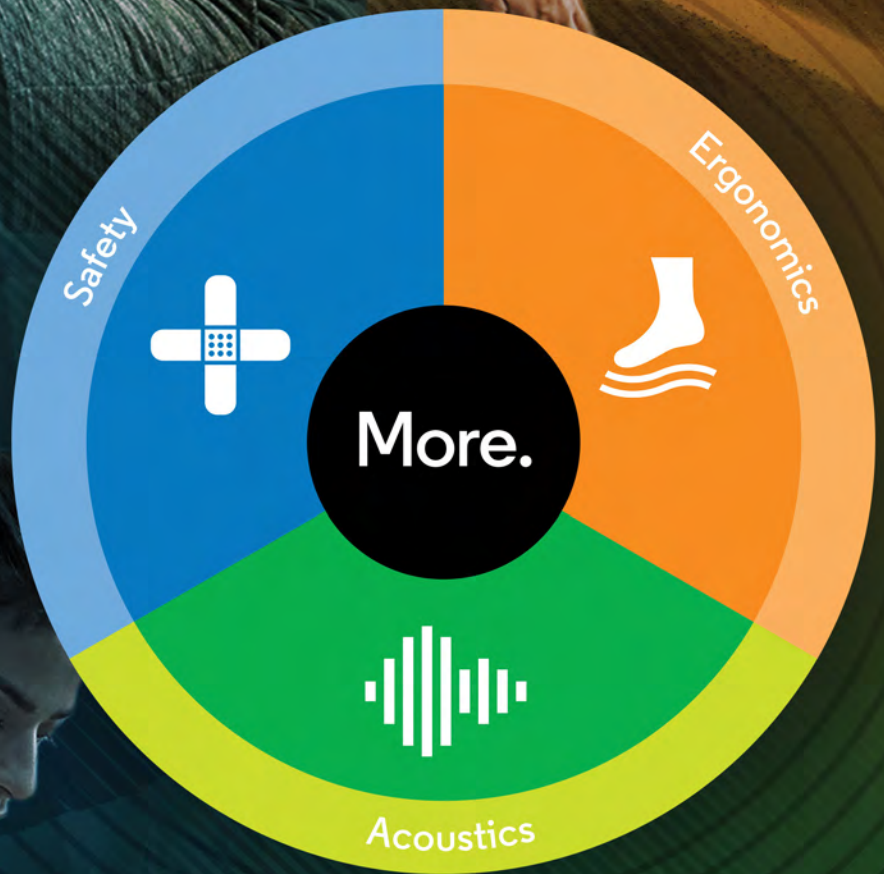

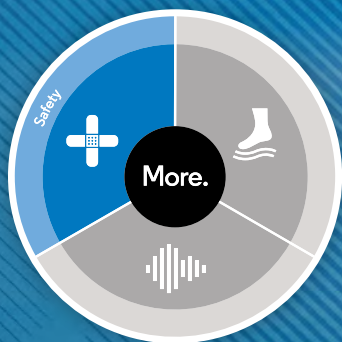

The Promise of
Safety

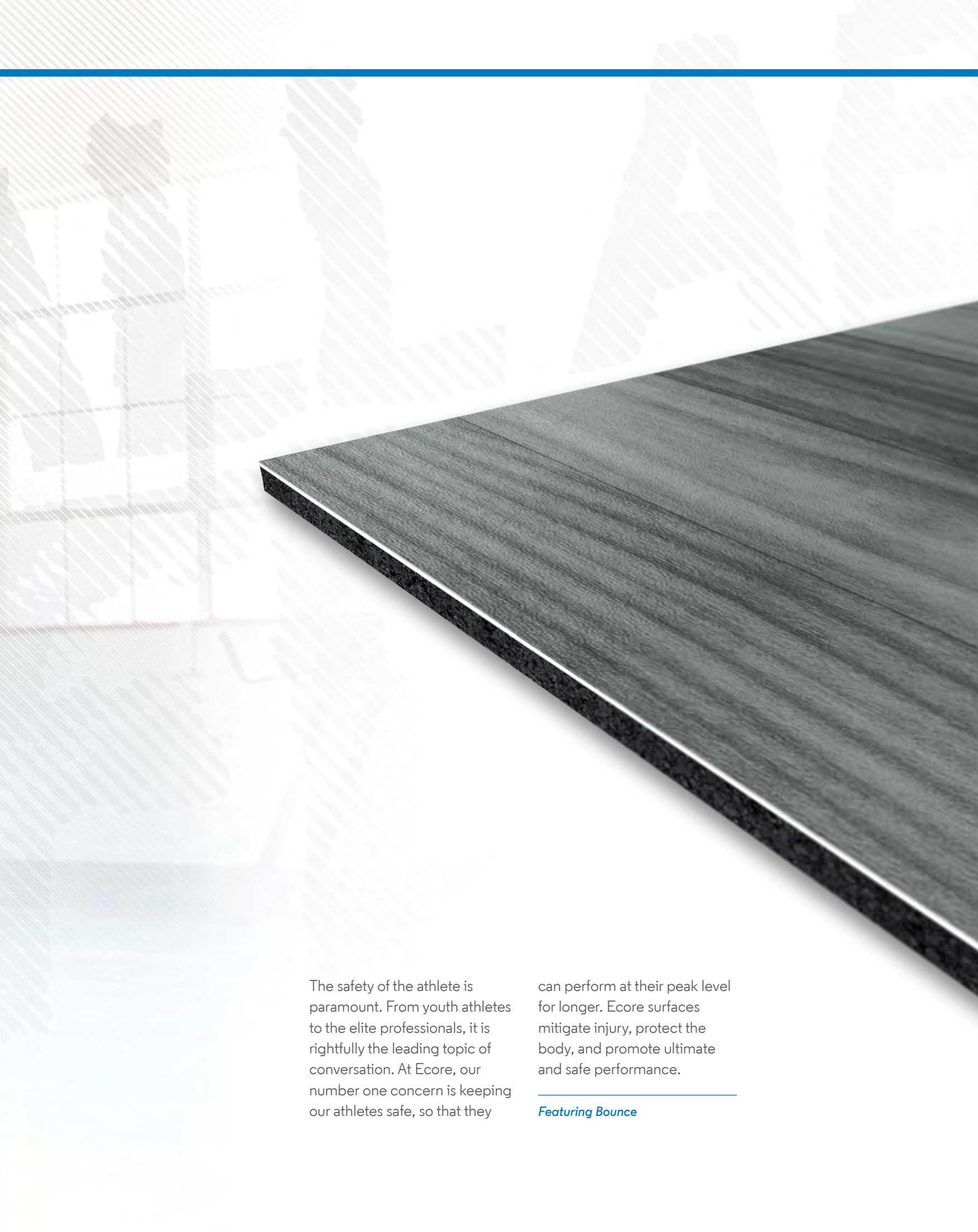

The safety of the athlete is paramount. From youth athletes to the elite professionals, it is rightfully the leading topic of conversation. At Ecore, our number one concern is keeping our athletes safe, so that they

can perform at their peak level for longer. Ecore surfaces mitigate injury, protect the body, and promote ultimate and safe performance.

Featuring Bounce

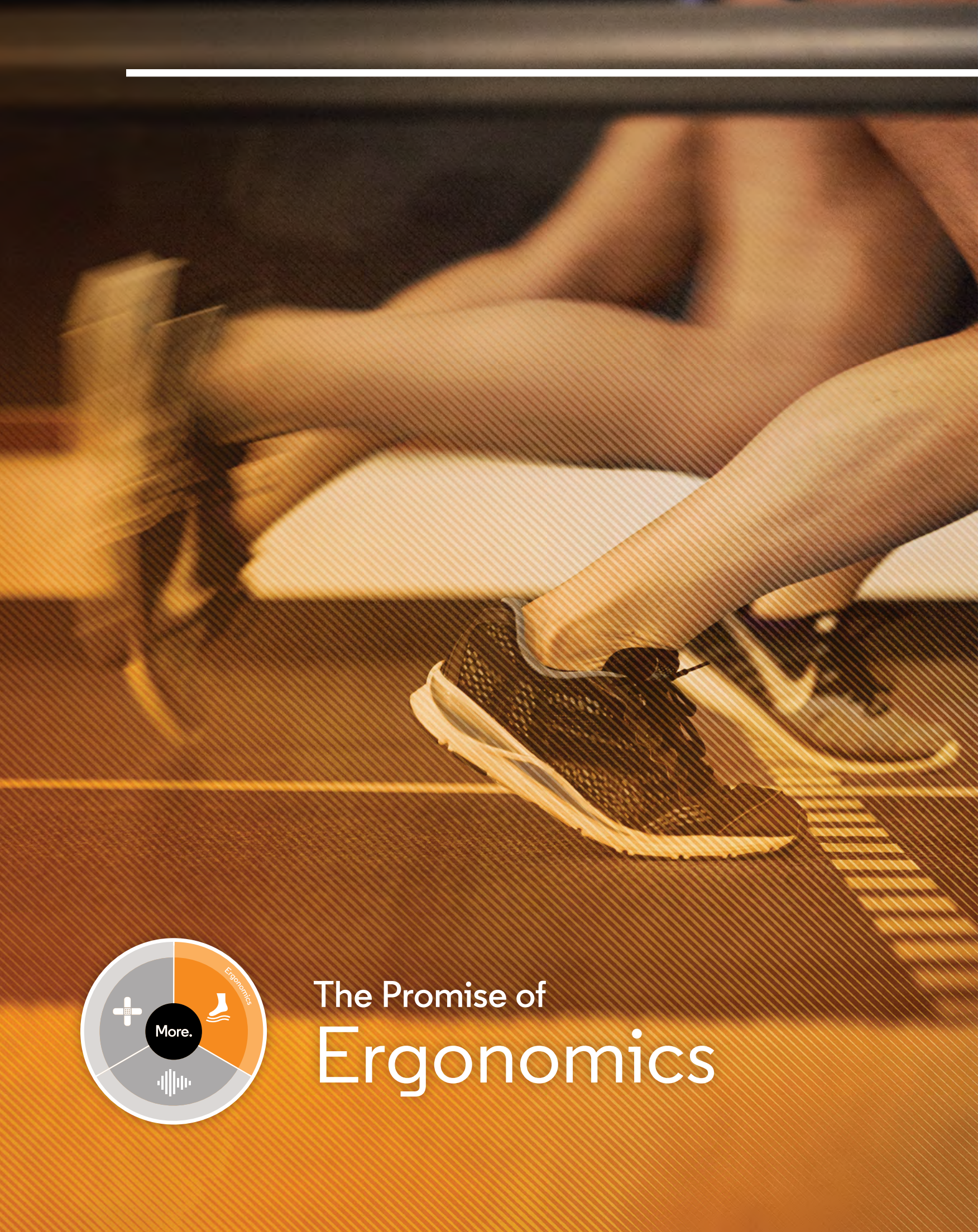

The Promise of
Ergonomics

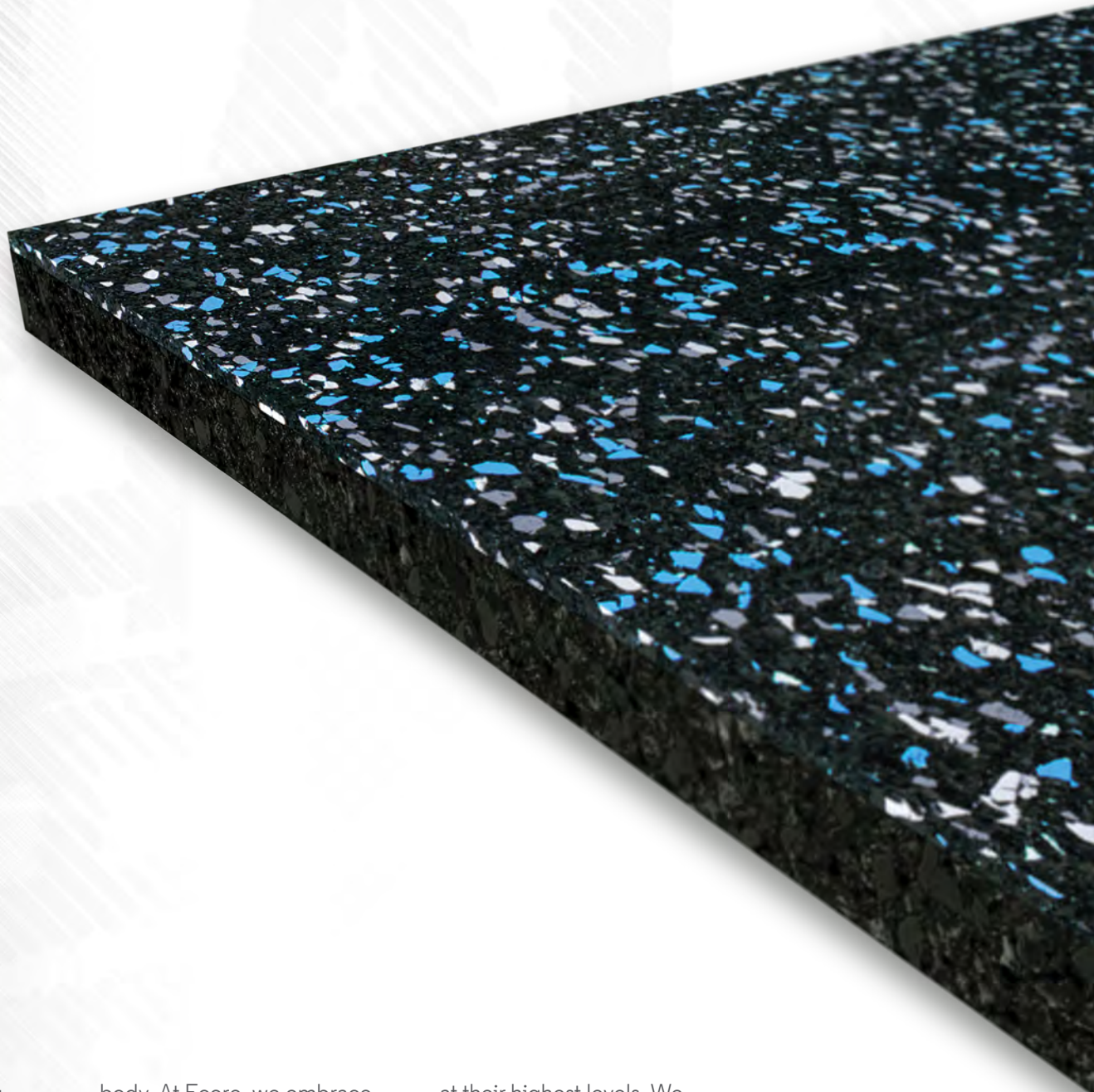

Running. Jumping. Falling.
And bouncing back. Time and
time again. From the casual
workout warrior to the serious
athlete, repetitive motion,
swift movement, and constant
impact can take a toll on the

body. At Ecore, we embrace
the science of Ergonomics—
the absorption of force and the
return of energy. We develop
flooring solutions that diminish
fatigue, minimize discomfort,
and allow athletes to perform

at their highest levels. We
make surfaces that sponsor
longevity through innovative
engineering and design.

Featuring Rally



The Promise of
Acoustics



The more energy a product absorbs, the shorter its life cycle. For a product to absorb a lot of energy, it must be made of a material that will deflect, allowing the falling

object to penetrate or sink into the material. Ecore products feature a firm yet energy absorbing foundation that meets all physical requirements while maximizing acoustical

performance and therefore reducing noise in and between functional spaces overall.

Featuring SmashTile



Find your perfect Flooring Solution.

		Force Reduction	Energy Restitution
1	Everlast Collection		
4	Basic Rolls & Tiles	10.4	71.9
6	UltraTile	50.2	47.9
10	SmashTile	67.7	46.1
15	Performance Collection		
18	Motivate	14.4	66.8
20	Rally	35.4	53.7
22	Beast	11.4	72.2
24	Monster	38.1	53.5
28	Speed & Agility Turf	36.9 (8mm) 53.4 (15mm)	46.1 (8mm) 40.2 (15mm)
31	Elevate Collection		
34	Roster	19.1	62.8
36	Bounce 2	11.9	68.4
40	Spectator	-1.5	79.2
42	Frictional	-0.3	78.6
44	Aqueous	-1.7	78.8
46	Surface America		





Everlast Collection

Durable

Safe

Superior

The Everlast Fitness Flooring family of products has been manufactured by Ecore since 1989. Each product in this offering consists of composition rubber.

Everlast Fitness Flooring is durable, while having excellent slip-resistant properties. Rubber's inherent traits make it superior at absorbing impact force. This unique combination of attributes makes composition rubber the ideal choice for fitness applications.

Everlast

PRODUCTS	PRODUCT FEATURES		CONSTRUCTION			
Everlast Collection	Description	Benefits	Colors	Rolls	Tiles	Planks
Basic Rolls & Tiles	Composition rubber floor	Durable, easy to maintain, slip-resistant	24	●	●	
UltraTile®	Beveled tile featuring a patented footed system	Modular, easy installation & maintenance, slip-resistant, ADA compliant	17		●	
SmashTile	Molded tile featuring a patented wear layer	Extreme durability, ultimate sound and shock absorption	17		●	

Basic Rolls & Tiles

A top choice for fit-minded people and athletes that stands up to consistent daily pounding.



Basic Rolls and Tiles are the “original” composition rubber fitness floor. Available in rolls and tiles, this durable surface sets the standard for performance, quality, and affordability.

Markets

Fitness
Student Rec

Benefits

Shock absorbent
Durable
Affordable
Easily maintained

Color Options

(All colors not shown; visit ecoreathletic.com for additional color options.)



Basic Black
EL00



Buff Blue 10
EL01



Grippin Gray 10
EL02

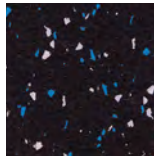

Buff Blue / Gray 10
EL04

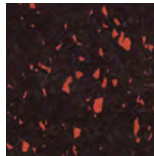

Rippin Red 10
EL05



Steel Appeal 2
EL15A

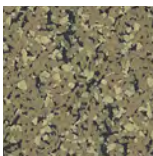

Mocha Latte 2
EL43A

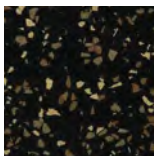

Wildcats 3
EL100B

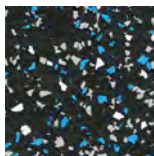

Blue Jays
EL103

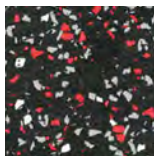

Cardinals
EL104



Dark Gray
EL502

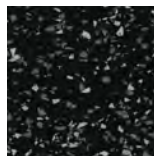

Raiders
EL503

Dimensions

Rolls	8mm x 48" (1.22m) 6mm x 48" (1.22m) standard/custom 9mm x 48" (1.22m) standard/custom
-------	---

Interlocking Tiles	8mm x 23" x 23" (58cm)
--------------------	------------------------

All colors may not be available in all formats; refer to website for additional color and format options.

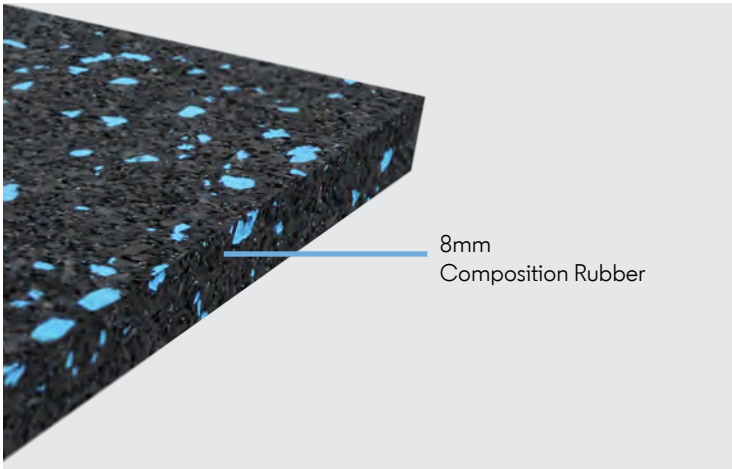

8mm
Composition Rubber

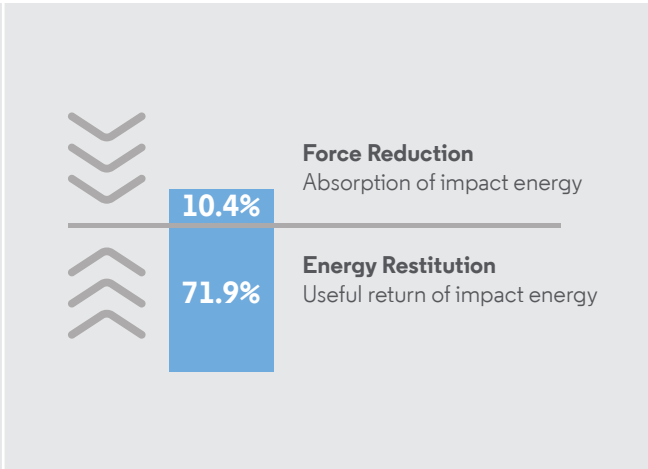

UltraTile®

This premium composition rubber flooring provides unrivaled comfort, safety, and noise control.



UltraTile is designed with a patented “ultra” high-density wear layer on a molded base. This 24-by-24-inch modular tile offers enhanced shock absorption against impact in moderate to extreme weight drop applications.

Markets

Fitness
Sports
Student Rec

Benefits

15 year warranty
Sound and shock absorbent
Easy installation with Quad Blok installation system
Slip-resistant, wet or dry
Extremely durable
Custom color and logo options

Color Options

(All colors not shown; visit ecoreathletic.com for additional color options.)



Basic Black
EL00

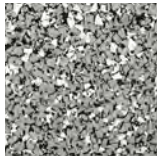

Steel Appeal 2
EL15A

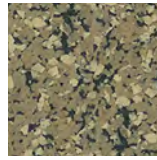

Mocha Latte 2
EL43A

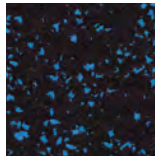

Buff Blue 20
EL45

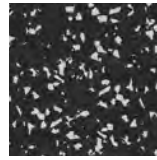

Gripping Gray 20
EL46

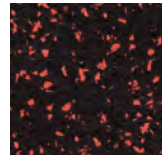

Rippin Red 20
EL47

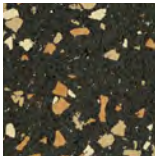

Wildcats 3
EL100B

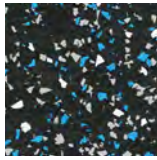

Blue Jays
EL103

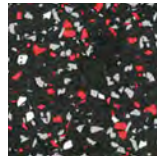

Cardinals
EL104

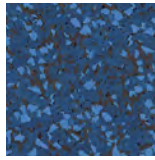

Blue
EL500

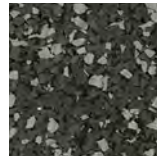

Dark Gray
EL502

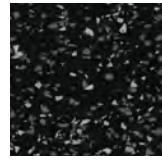

Raiders
EL503

Dimensions

Tiles 1" x 24" (61cm) x 24" (61cm)

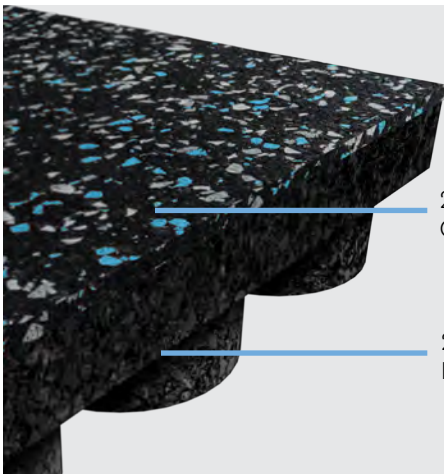

2.5mm
Composition Rubber

22.9mm
Molded Base



50.2%

Force Reduction

Absorption of impact energy



47.9%

Energy Restitution

Useful return of impact energy

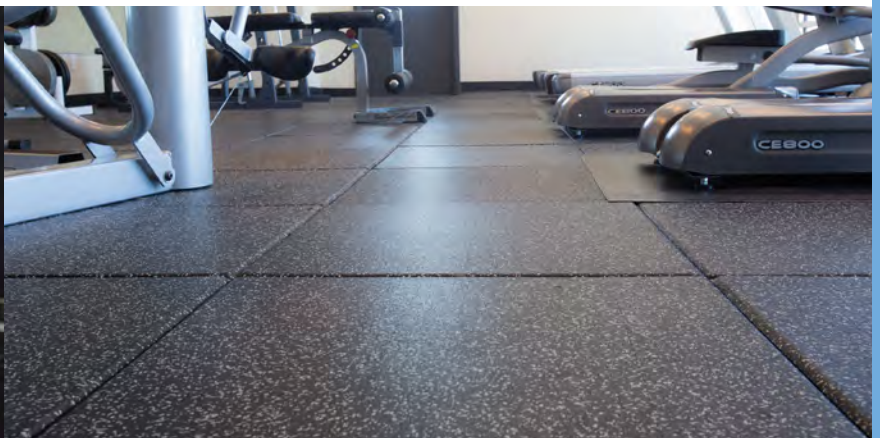

The Lyon Center University of Southern California

Los Angeles, CA

The Challenge.

As one of the world's leading private research universities, USC not only focuses on academics but also encourages an active lifestyle by providing free gym memberships to all students.

As a result of this heavy daily stream of students, USC recognized that updating the floor in the Klug Family Fitness Center weight room would remedy the existing tripping hazard and allow migration of the equipment around the space. The material would have to be low-maintenance, sound- and shock-absorbent, and visually appealing.

The Lyon Center also needed to upgrade its locker rooms. The new floor not only needed to look better than the existing ceramic tile, but it also had to absorb impact force should someone still fall.

Our Solution: **UltraTile®** & **Rally**.

2,000 square feet of Everlast UltraTile was installed in USC's weight facility. The surface's patented "ultra" wear layer on a molded base provides superior noise and shock absorption. The ergonomic option of UltraTile reduces the constant impact of repetitive training, giving the students the best support in their daily routines.

In the locker room upgrade, 7,000 square feet of Performance Rally was installed. This 14.5mm dual durometer system is engineered to absorb impact force. It's much safer than ceramic tile, and meets both the aesthetic and functional needs of such a high-use area.



Collections: Everlast & Performance

Products: UltraTile & Rally

Dimensions: 2,000 sq ft Ultratile/ 7,000 sq ft Rally



SmashTile

For areas with heavy weights and impacts, where shock and sound absorption are critical.



This 2-foot by 2-foot by 2.5-inch molded tile is designed for areas where extreme durability and ultimate sound and shock absorption are required. SmashTile mitigates the shock and sound resulting from large weight being released onto its surface by absorbing impact. SmashTile is the perfect complement to platform style weight lifting.

Markets

Fitness
Sports
Student Rec

Benefits

Superior sound and shock absorption
Patented “ultra” high-density wear layer
Slip-resistant
Easy installation with Quad Blok installation system

Color Options

(All colors not shown; visit ecoreathletic.com for additional color options.)



Basic Black
EL00

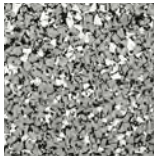

Steel Appeal 2
EL15A

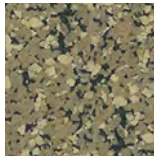

Mocha Latte 2
EL43A

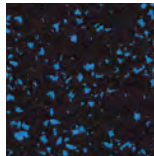

Buff Blue 20
EL45

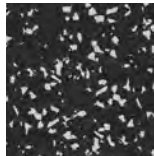

Gripping Gray 20
EL46

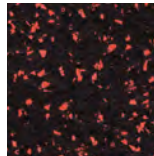

Rippin Red 20
EL47

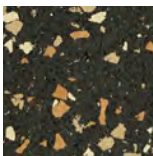

Wildcats 3
EL100B

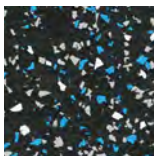

Blue Jays
EL103

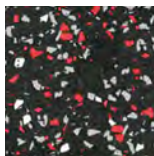

Cardinals
EL104

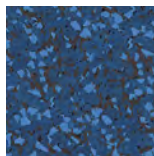

Blue
EL500

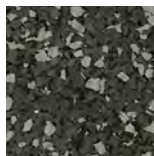

Dark Gray
EL502

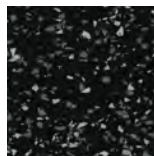

Raiders
EL503

Dimensions

Tiles 2.5" x 24" (61cm) x 24" (61cm)

2.5mm
Composition Rubber

61mm Molded
Base Layer

67.7%	Force Reduction Absorption of impact energy
46.1%	Energy Restitution Useful return of impact energy



If the athlete matters, the surface they use matters.

Ecore creates surfaces that capture the negative energy of impact and return **positive energy** to the athlete.

NRG Factor:

Managing Force Reduction and Energy Restitution to deliver optimal performance.







Performance Collection

Quiet

Safe

Customizable

This family of products offers everything an athletic director or head coach needs to create an ideal training and performance environment for his or her athletes.

Performance

PRODUCTS	PRODUCT FEATURES		CONSTRUCTION			
	Description	Benefits	Colors	Rolls	Tiles	Planks
Performance Collection						
Motivate	Colorful rubber wear layer fusion-bonded to a cushion composition rubber backing	Sound and shock absorption during fitness activities	12	●		
Rally	Fusion-bonded ergonomic floor	Dynamic energy return, comfort, and slip resistance while standing or walking	13	●	●	
Beast	Fusion-bonded for heavy strength training	Extreme durability, maximum energy restitution	13	●		
Monster	Fusion-bonded for extreme strength and conditioning	Durability and firm footing in strength training, ergonomic in functional training	13	●		
Speed & Agility Turf	Turf fusion-bonded to composition rubber, interlocking tile is ideal for portable/temporary turf systems	Non infill turf, ideal for footwork drills including hills and sled lanes	1	●	●	

APPLICATIONS

Restrooms	Locker Rooms	Cardio	Entrances & Common Areas	Light Weight Areas	Moderate Weight Areas	Extreme Weight Areas	Strength Equipment	Functional Training	Group Exercise	Indoor Turf	Food Service Area	Wet Areas	Retail	Ice Rinks	Tracks
		•		•			•								
		•		•	•		•	•							•
		•		•	•	•	•								
		•		•	•	•	•	•							
				•	•			•		•					

Motivate

Colorful wear layers fused with durable composition rubber support daily workouts and functional training.



Tailored for light strength and conditioning, this 7.5mm surface combines an Ecore wear layer with a 5mm base layer. The result: a balanced distribution of force reduction and energy restitution, designed for the shift in fitness from equipment to more functional training.

(For indoor use only.)

Markets

Fitness

Sports

Student Rec

Benefits

Sound and shock absorbent

Fade resistant/wears well

Slip-resistant wet or dry

Color Options



Steel Appeal 2
ES15A

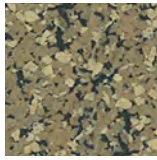

Mocha Latte 2
ES43A



Wildcats 2
ES100A

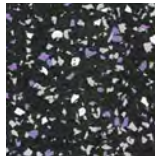

Vikings
ES101

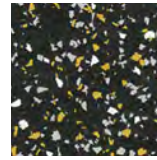

Lions
ES102

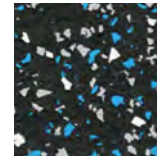

Blue Jays
ES103

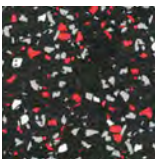

Cardinals
ES104

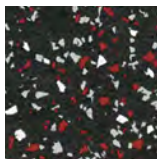

Devils
ES105

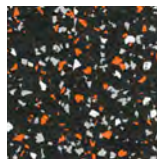

Tigers
ES106

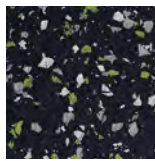

Gators 2
ES107A

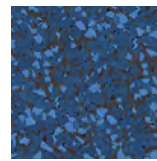

Blue
ES500



Dark Gray
ES502

Dimensions

Rolls

7.5mm (2.5mm+5mm) x 48"

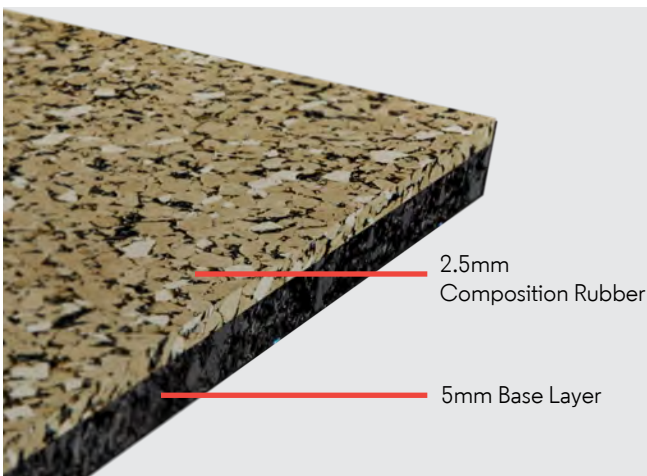

14.4%

Force Reduction

Absorption of impact energy



66.8%

Energy Restitution

Useful return of impact energy

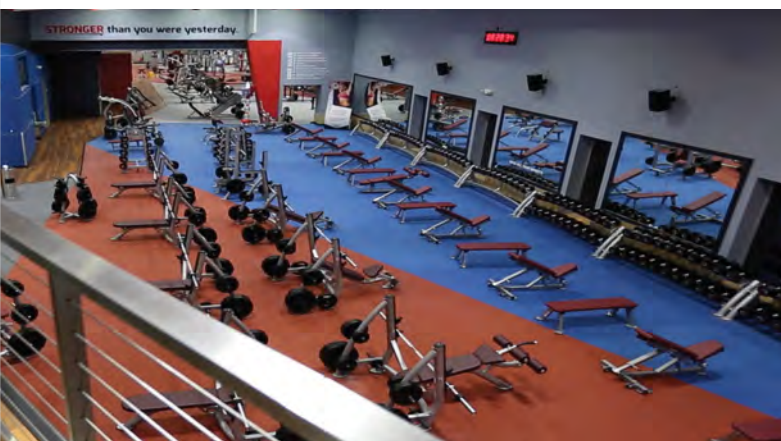

Rally

Working with the total athlete to absorb impact and return energy to accelerate daily training.



Tailored for heavy conditioning, this 14.5mm product showcases a dynamic force reduction of 35.40%. This dual durometer system is engineered to absorb the impact force related to aggressive functional training, providing an ergonomically advanced surface that works in concert with the body.

(For indoor use only.)

Markets

Fitness
Sports
Student Rec

Benefits

Sound and shock absorbent
Fade resistant/wears well
Slip-resistant wet or dry

Color Options

(All colors not shown; visit ecoreathletic.com for additional color options.)



Basic Black
ES00

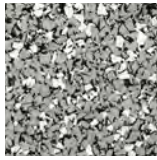

Steel Appeal 2
ES15A

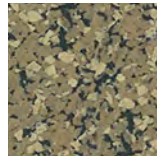

Mocha Latte 2
ES43A

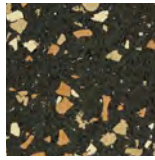

Wildcats 2
ES100A

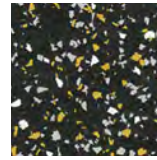

Lions
ES102

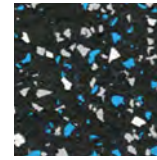

Blue Jays
ES103

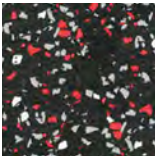

Cardinals
ES104

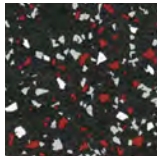

Devils
ES105

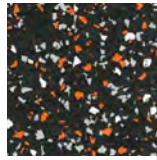

Tigers
ES106

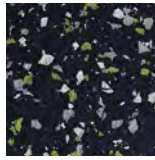

Gators 2
ES107A

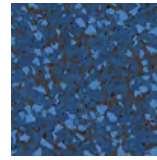

Blue
ES500

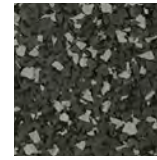

Dark Gray
ES502

Dimensions

Rolls 14.5mm (2.5mm+12mm) x 48"

Interlocking Tiles 14.5mm (2.5mm+12mm) x 23" x 23"

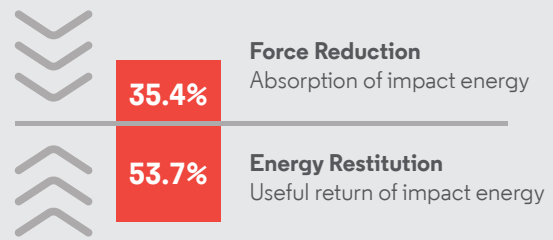
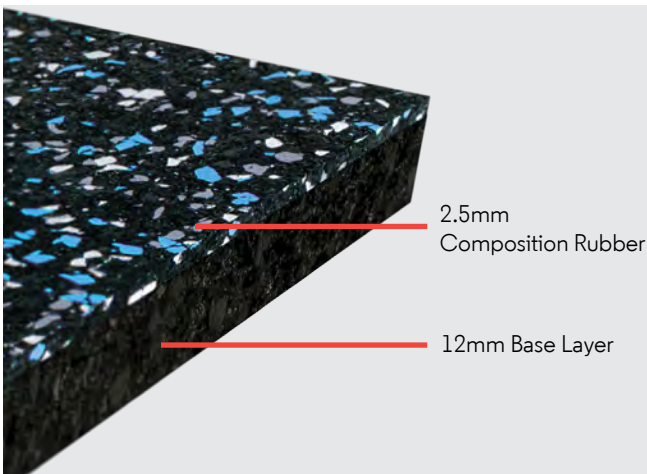

Beast

For areas primarily used for free weight training.



Designed for heavy strength training, this 10.5mm system features an angry base layer that maximizes energy restitution. This dual durometer system is engineered to enhance durability in applications dominated by free weight training.

(For indoor use only.)

Markets

Fitness

Sports

Student Rec

Benefits

Sound and shock absorbent

Fade resistant/wears well

Slip-resistant wet or dry

Color Options

(All colors not shown; visit ecoreathletic.com for additional color options.)



Basic Black
ES00



Steel Appeal 2
ES15A

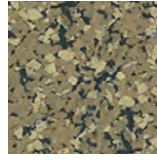

Mocha Latte 2
ES43A



Wildcats 2
ES100A

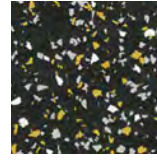

Lions
ES102

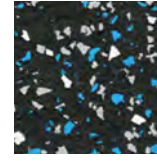

Blue Jays
ES103

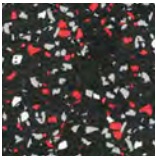

Cardinals
ES104

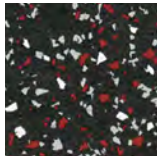

Devils
ES105

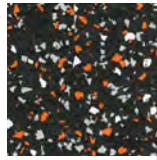

Tigers
ES106

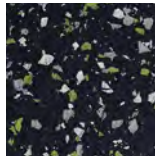

Gators 2
ES107A

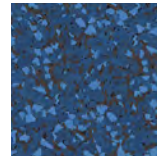

Blue
ES500

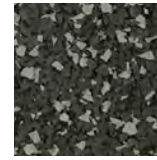

Dark Gray
ES502

Dimensions

Rolls

10.5mm (2.5mm+8mm) x 48"

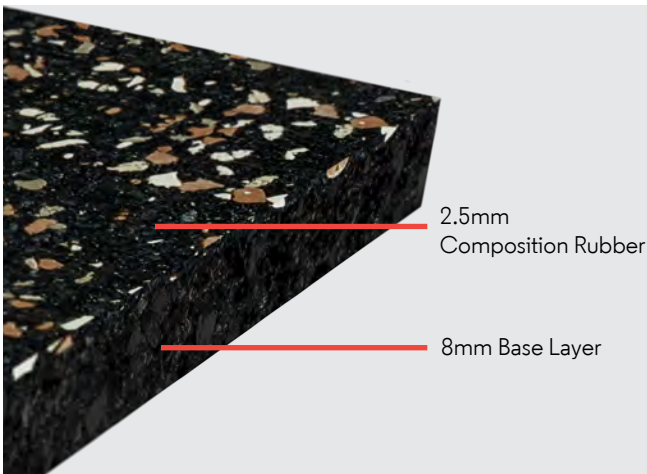

11.4%

Force Reduction

Absorption of impact energy



72.2%

Energy Restitution

Useful return of impact energy



Monster

Supporting the elite athlete by providing the ultimate support for daily workouts and flexibility in design.



Custom-made for extreme strength and conditioning, this 22.5mm system features a 10.5mm Performance Beast Roll field united to a 12mm ShockPad. The resulting triple durometer system combines the durability and firm footing desired in strength training with the ergonomic demands of aggressive functional training in one surface.

(For indoor use only.)

Markets

Fitness

Sports

Student Rec

Benefits

Sound and shock absorbent

Fade resistant/wears well

Slip-resistant wet or dry

Color Options

(All colors not shown; visit ecoreathletic.com for additional color options.)



Basic Black
ES00

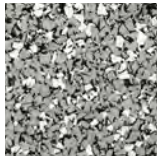

Steel Appeal 2
ES15A

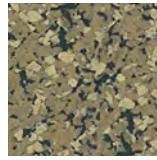

Mocha Latte 2
ES43A

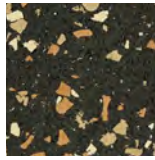

Wildcats 2
ES100A

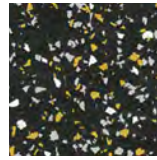

Lions
ES102



Blue Jays
ES103

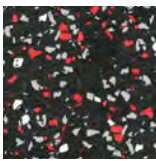

Cardinals
ES104

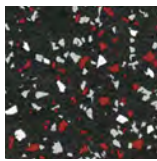

Devils
ES105

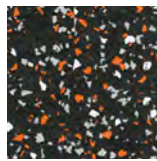

Tigers
ES106

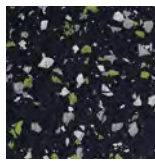

Gators 2
ES107A

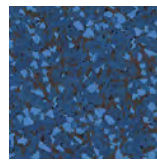

Blue
ES500



Dark Gray
ES502

Dimensions

Rolls

22.5mm (2.5mm+8mm+(12mm)) x 48"

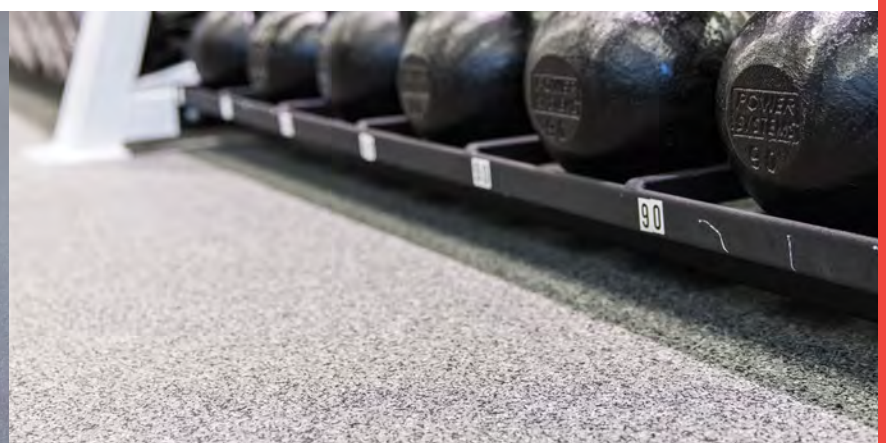
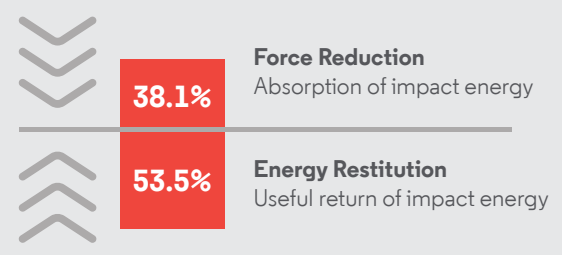
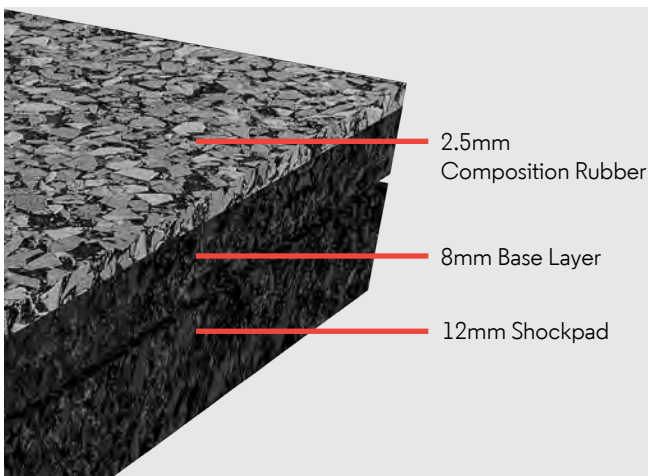

San Diego State University Athletic Center

San Diego, CA

The Challenge.

At a Division I school like San Diego State University (SDSU), sports are serious business. When SDSU renovated the Fowler Athletic Center, the 4-story, 130,000-square foot facility had to work for all of its sports programs.

The renovation particularly focused on the 13,000-square foot weight room, with a goal to become more competitive with other D1 schools and provide a more efficient training space for the 85 football players training at any given time. The existing floor was less than half an inch thick, resulting in a negative impact on athletes' joints, weights bouncing in an unsafe way, and generally unappealing wear and tear.

Our Solution: **Monster.**

The team found a solution in Ecore Monster, a 22.5-millimeter thick rubber athletic surface that is designed for extreme strength and conditioning. This triple durometer system combines the durability and firm footing needed for intense strength training with the ergonomic performance necessary for aggressive functional training.

The new weight room surface features 25 in-laid Olympic weightlifting platforms complete with custom logos. Today, up to six athletes are able to work at each weightlifting station at the same time. The shock-absorbent floors minimize weight bounce and joint impact, allowing the SDSU football team to train safely.



Collection: Performance

Product: Monster

Dimensions: 13,000 sq ft



Speed & Agility Turf

Durable and resistant to slips, this tight-weaved turf-like product is ideal for functional and competitive training.



This turf features an extremely dense, textured, nylon wear layer fusion-bonded to a 5mm or 12mm base layer. This consistent, tight surface is ideal for footwork drills and sled work.

(For indoor use only.)

Markets

Fitness

Student Rec

Benefits

No infill

Portable (Interlocking Tile)

Meets specifications for competitive field hockey, lacrosse, and soccer fields

Available in Turf Green as shown.



Dimensions

Rolls

8mm (3mm + 5mm) x 72" (1.83m) x 35LF (10.67m)
 15mm (3mm + 12mm) x 72" (1.83m) x 25LF (7.62m)
 Custom roll lengths are available.

Interlocking
 Tiles

15mm (3mm + 12mm) x 23" (58.42cm) x 46" (116.84cm)
 Interlocking tiles are available with a coordinating interlocking transition system.

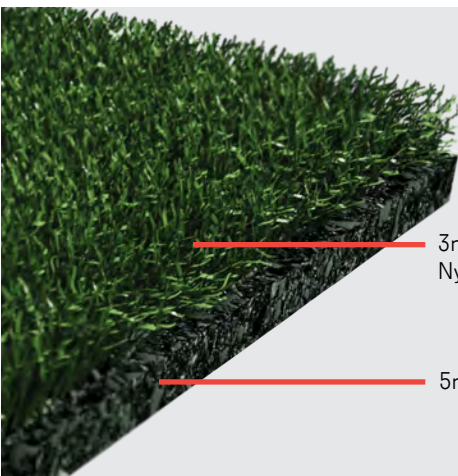

3mm Dense
 Nylon Wear Layer

5mm Base Layer



36.9%

Force Reduction
 Absorption of impact energy



46.1%

Energy Restitution
 Useful return of impact energy

Data for 8mm thickness

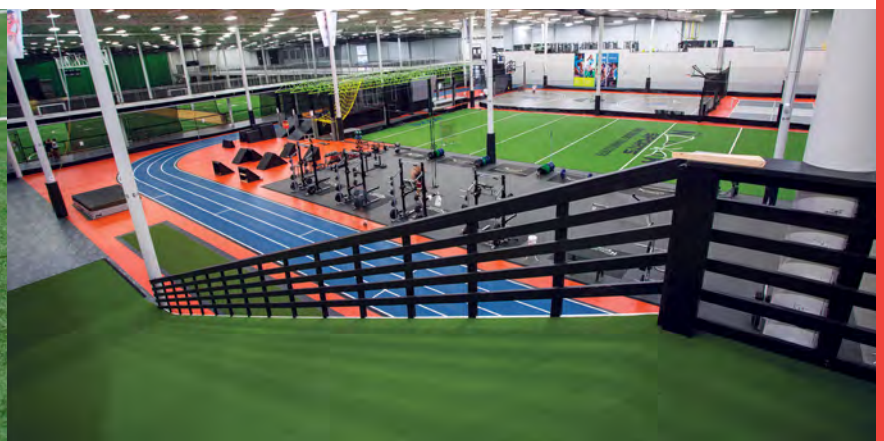



Elevate Collection

Low-maintenance

Welcoming

Slip-resistant

Elevate is a collection of products designed to elevate the fitness space from the entryway to locker room.

Elevate

PRODUCTS	PRODUCT FEATURES		CONSTRUCTION			
	Description	Benefits	Colors	Rolls	Tiles	Planks
Performance Collection						
Roster	Non-woven fusion-bonded to composition rubber, interlocking tile is ideal for portable/temporary systems	Durable, portable, and easy to install	3		●	
Bounce 2	Heterogeneous sheet vinyl with a fusion-bonded rubber base layer	Quiet underfoot, ergonomic, low maintenance due to protective wear layer	6	●		
Spectator	Luxury vinyl tile	Durable in heavy commercial areas	16		●	●
Frictional	Vinyl safety floor	Slip-resistant, enhanced coefficient of friction to prevent falls	6	●		
Aqueous	Vinyl safety floor	Extreme slip-resistant	5	●		

APPLICATIONS

Restrooms	Locker Rooms	Cardio	Entrances & Common Areas	Light Weight Areas	Moderate Weight Areas	Extreme Weight Areas	Strength Equipment	Functional Training	Group Exercise	Indoor Turf	Food Service Area	Wet Areas	Retail	Ice Rinks	Tracks
•	•		•										•		
	•	•	•						•						
•	•		•								•		•		
•	•										•				
												•			

Roster

This durable product is perfect for high-traffic areas in fitness centers or gyms.



Roster features a unique non-woven surface that is fusion-bonded to a 5mm base layer and is offered in an interlocking format. This product is ideal for entryways or transition areas.

(For indoor use only.)

Markets

Fitness

Sports

Student Rec

Benefits

Durable

Portable

Provides moisture mitigation

Easy to install

Color Options



Blue



Brown



Charcoal

Dimensions

Interlocking Tiles	23" Interlocking Tiles (7mm) 7mm (2mm + 5mm) x 23" (58cm) x 23" (58cm)
--------------------	---

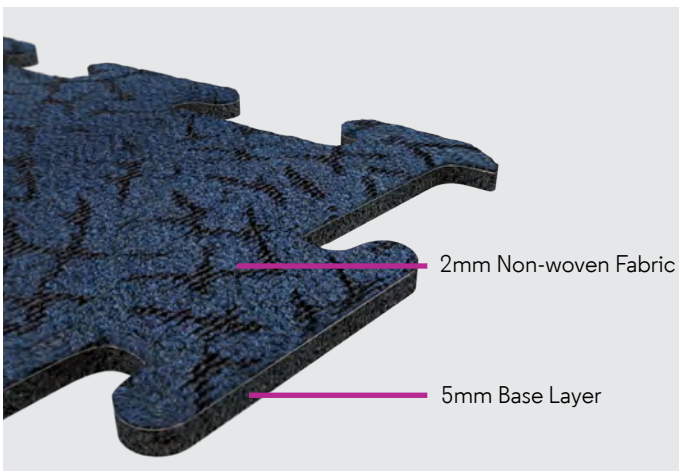

19.1%

Force Reduction

Absorption of impact energy



62.8%

Energy Restitution

Useful return of impact energy



Bounce 2

For courts, dance, and group fitness, Bounce 2 contributes to the overall safety of the environment.



Bounce 2 features a synthetic wood-grain surface that is fusion-bonded to a 5mm base layer. The result is beautiful flooring that looks like real wood, but is more economical, durable, and easier to clean.

(For indoor use only.)

Markets

Fitness
Sports
Student Rec

Benefits

Hygienic because of heat welded installation
Quiet underfoot
Ergonomic
Low maintenance due to protective wear layer
Can paint lines on surface

Color Options

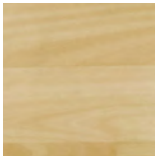

Wheat
ES203

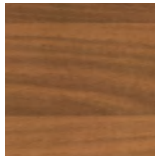

Chestnut
ES204

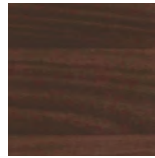

Chocolate
ES205

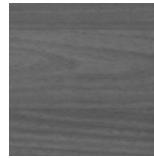

Graphite
ES206



Sandstone
ES207



Slate
ES208

Dimensions

Rolls 7mm (2mm + 5mm) x 72" (1.83m) x 30LF (9.14m). Weld rod required.

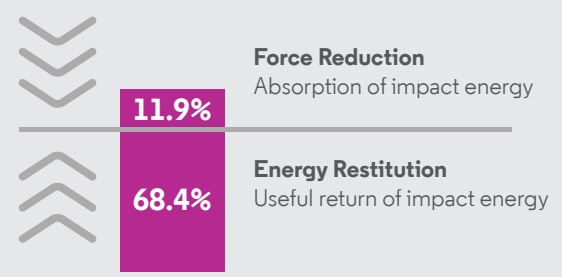
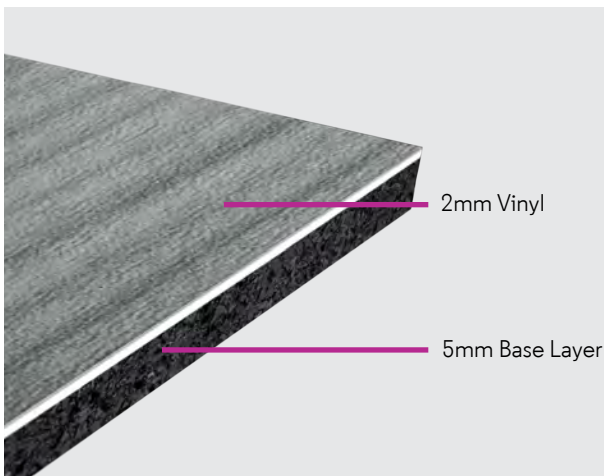

Crunch Fitness

Stockton, CA

The Challenge.

Crunch Fitness is a heavy-lifter in the fitness industry, but one of the challenges of being a quickly growing franchise is making sure that members at every location get the same high-quality, high-performance experience.

With nearly 30 different types of classes and 3,000 members working out at a single location, finding a floor that increases safety, decreases impact and shock, and absorbs enough sound so the gym doesn't sound like an echo chamber is no easy feat.

Our Solution: **Bounce 2.**

Both Ecore and Crunch want athletes and fitness buffs to get an elite experience. In 2015, Ecore inked a deal with the fitness giant to be the exclusive provider of all athletic surfaces for its gym locations.

To enhance Crunch's brand, Ecore provides Rally for the general fitness and free weight area in a custom blue color, and Motivate for the ride studio in custom red, along with Bounce 2 in graphite for their Group X studios, and a special Crunch Turf for their turf areas. The result is a comprehensive flooring system that is engineered to absorb the impact and sound related to aggressive functional training, while providing an ergonomically advanced surface that works in concert with the body and is safe for falls.

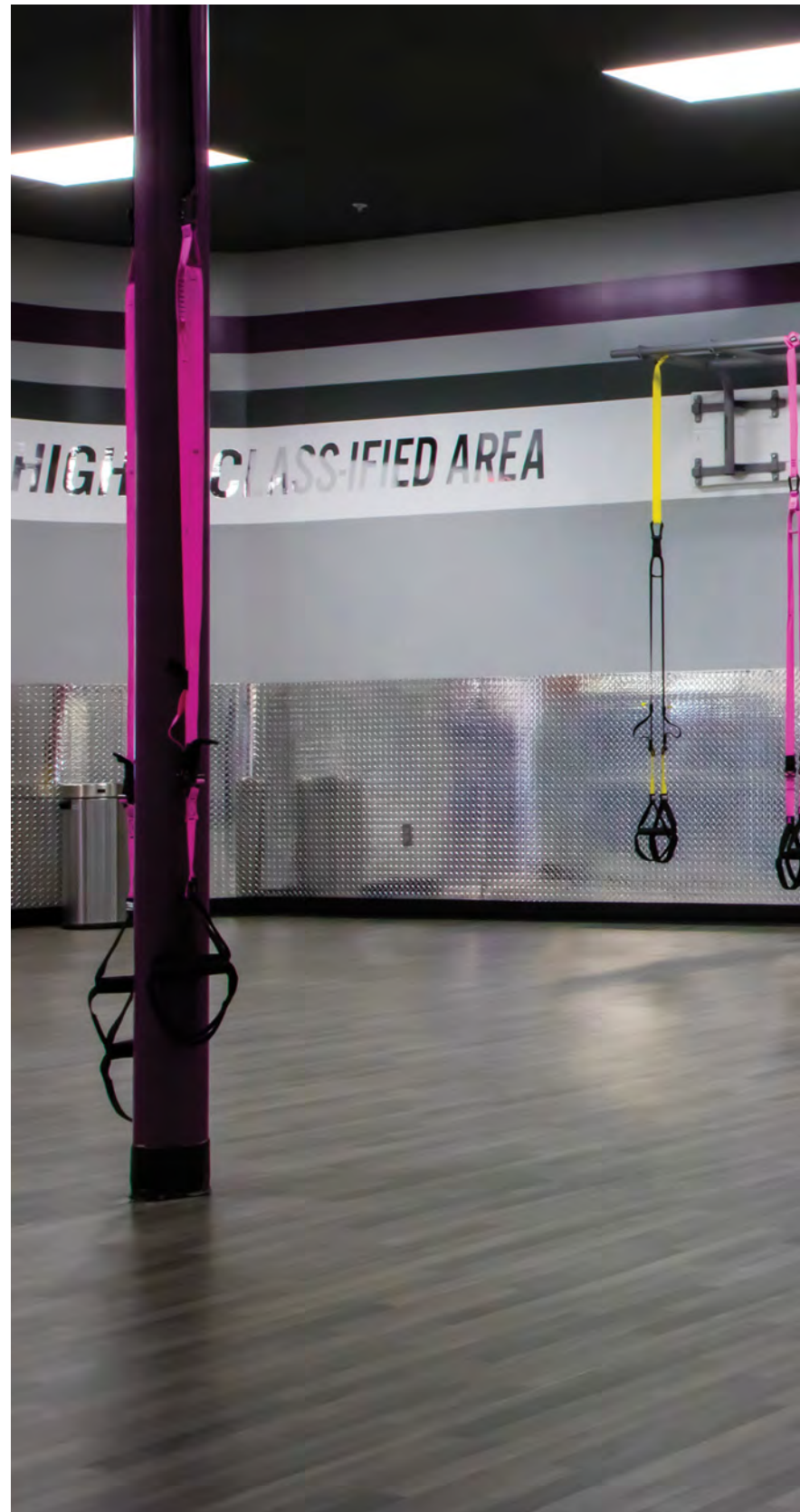

Collection: Elevate

Product: Bounce 2

Dimensions: 600 sq ft

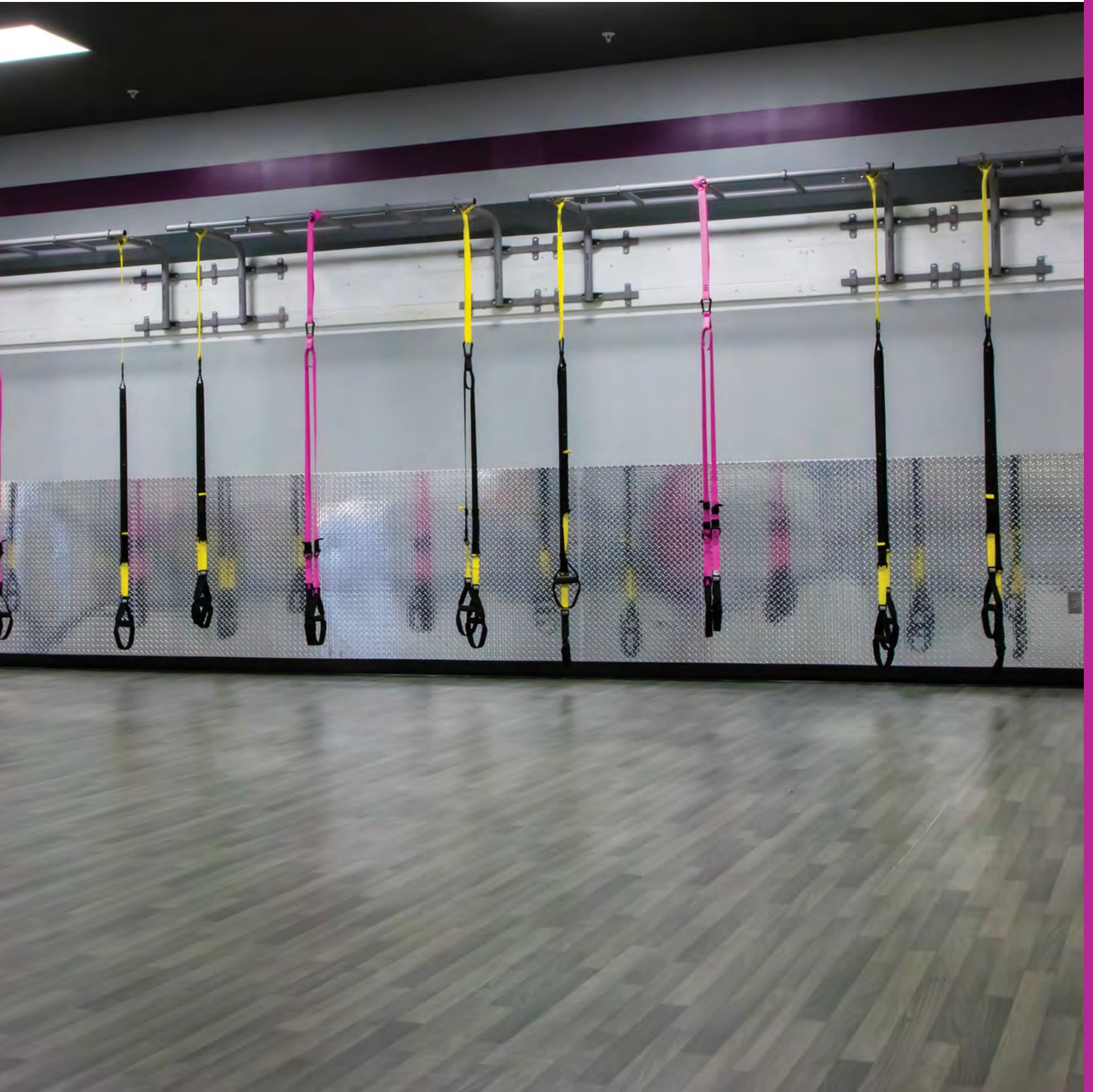

Spectator

Elevate your facility's common spaces with the beautiful finishes Spectator offers.



Spectator is a 2.5mm luxury tile in high-end wood and texture visuals. These planks and tiles are suited for heavy commercial areas within your facility.

Markets

Fitness

Sports

Student Rec

Benefits

High-end look

Designed for heavy commercial areas

Easy to install

Color Options

(All colors not shown; visit ecoreathletic.com for additional color options.)



Beach Oak
400

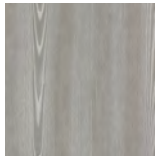

Light Ash
401



Saddle Oak
402



Golden Elm
405



Rich Walnut
406



Dark Ash
407

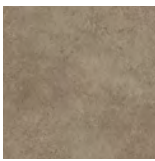

Urban Cement
450

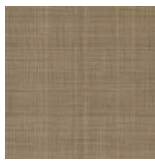

Mocha Linen
451



Smoked Cement
452



Buff Cement
454

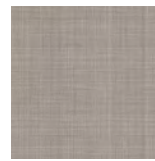

Steel Linen
456



Charcoal Linen
457

Dimensions

Wood
(except Dark Ash) 2.5mm x 6" x 36" (15cm x 491cm) planks

Dark Ash 2.5mm x 7" x 48" (18cm x 122cm) planks

Texture 2.5mm x 18" x 18" (46cm x 46cm) tiles

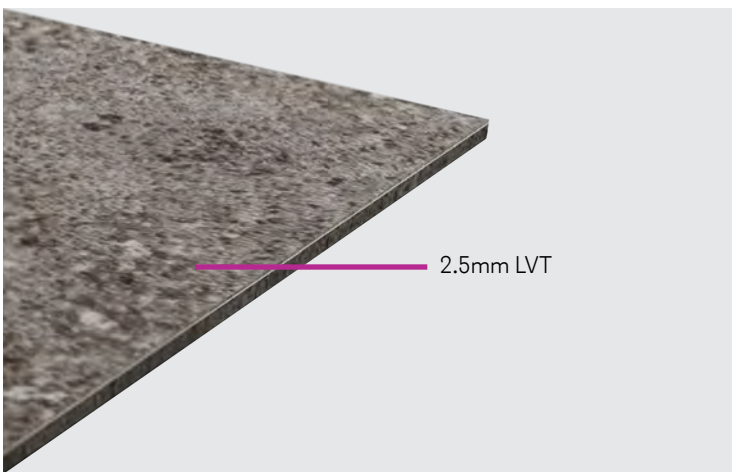

-1.5%

Force Reduction

Absorption of impact energy



79.2%

Energy Restitution

Useful return of impact energy

Frictional

For locker rooms and bathrooms, Frictional vinyl safety flooring prevents slips and falls.



Frictional is a 2mm vinyl safety flooring with an enhanced coefficient of friction to prevent falls in traffic areas where slipping may occur.

(Only available for sale in the United States.)

Markets

Fitness
Sports
Student Rec

Benefits

Slip-resistant
Designer look
Minimal maintenance
Easy to install

Color Options

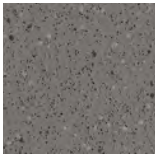

Nightsky
4760

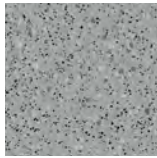

Woodland Gray
4770

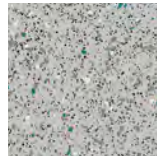

Whirlpool
4805

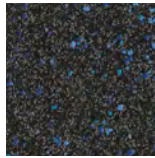

Galactic
4815

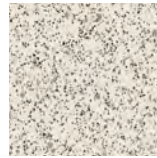

Bisque
4860

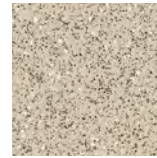

Barley
5500

Dimensions

Rolls 2mm x 6.56' W (2m) x 65.61LF (20m). Weld rod required.

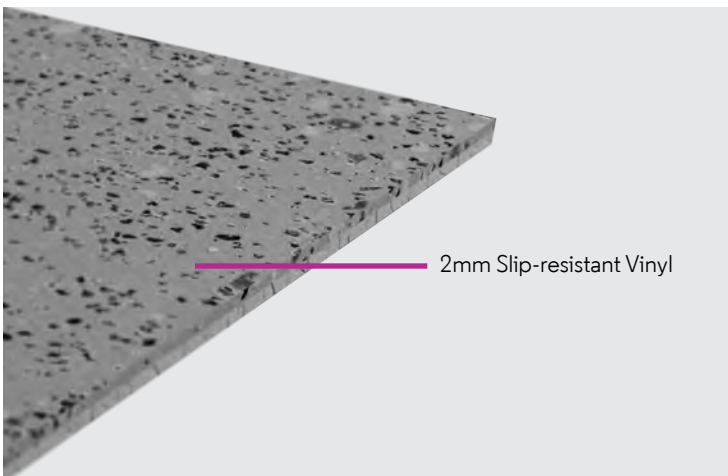

2mm Slip-resistant Vinyl



-0.3%

Force Reduction

Absorption of impact energy



78.6%

Energy Restitution

Useful return of impact energy

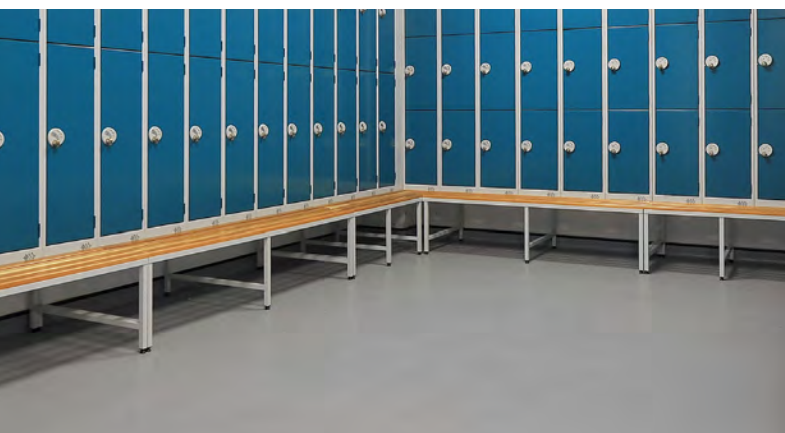

Aqueous

Slip-resistant surfacing provides a beautiful finish with minimal maintenance required.



This 2mm vinyl safety flooring is engineered with slip-resistant particles and a raised emboss for added slip resistance. Offered in 6-foot, 7-inch wide rolls with heat welded seams.

(Only available for sale in the United States.)

Markets

Sports

Fitness

Student Rec

Benefits

Slip-resistant

Designer look

Minimal maintenance

Easy to install

Color Options

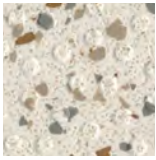

Amazon
4252

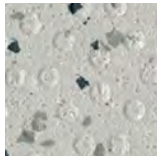

Colorado
4253

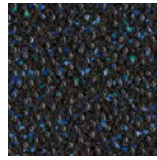

Black Volta
4255

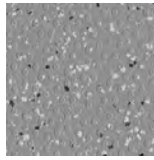

Tigris
4257

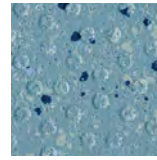

Adriatic
4258

Dimensions

Rolls 2mm x 6.56' W (2m) x 65.61LF (20m). Weld rod required.

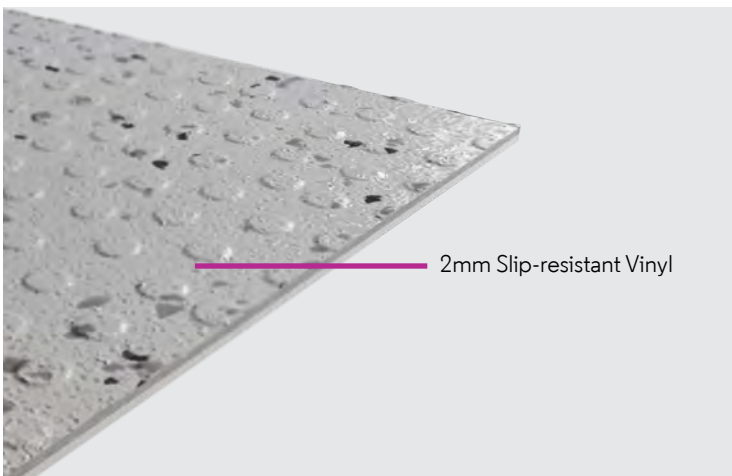

2mm Slip-resistant Vinyl



-1.7%

Force Reduction

Absorption of impact energy



78.8%

Energy Restitution

Useful return of impact energy



Surface America

Surface America is a subsidiary of Ecore that provides the complete installation of recreational and athletic surfacing. For 25 years, Surface America has provided project management, construction services, surfacing installation, supervision, and warranty service for thousands of projects throughout the U.S.

Every Surface America system is designed and manufactured with long-term performance in mind. Surface America selects the best material components available to design each surface with the characteristics necessary for the application.

Ecore Athletic is proud to offer the following Surface America systems.

Visit surfaceamerica.com for more information.



RecSport Turf Installed Outdoor System



RecSport Turf has the look of beautiful natural grass but with little maintenance and world-class toughness. This system features a polyethylene fiber tufted into a backing paired with a composition rubber base layer. The resilient base layer provides great shock absorption and the turf layer requires no infill.

Markets

Fitness
Student Rec
Sports

Benefits

Outdoor with perforations
for drainage
Custom logos, lines,
and designs
No infill needed

EverTop Outdoor Poured-in-Place System



EverTop is a half-inch, wet poured, one-layer, troweled-on-site system featuring polyurethane. This surface is specifically designed for outdoor multipurpose areas.

Markets

Fitness
Student Rec

Benefits

Outdoor
Custom logos, lines,
and designs
When used with aliphatic
urethane binder = 10-year
warranty; when used with
aromatic urethane binder =
7-year warranty.

ElastoFloor Poured-in-Place System



ElastoFloor Roll-Pour system is engineered specifically for use as an indoor basketball, volleyball, tennis, racquetball, squash, multi-sport court or track. This seamless surface consists of three layers of poured urethane over a pre-fabricated and fully adhered composition rubber base layer.

Markets

Fitness
Student Rec
Sports

Benefits

Shore A hardness, shock absorbent, installed system
Non-porous, excellent slip and wear resistance
Custom logos, lines, and designs





So, is the floor your most critical piece of equipment?

Yes.

A floor can be more than just a passive surface. By harnessing the attributes of recycled rubber, we've designed innovative ways to give you

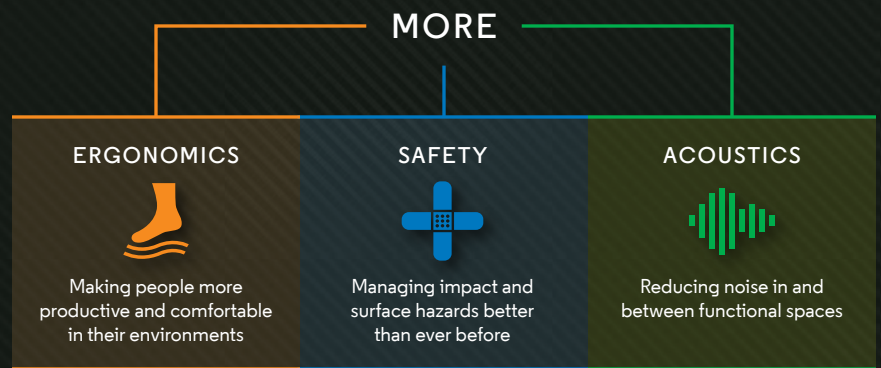

Bringing these attributes together in expert proportions, we've created tailored surfaces that make lives better, while also protecting the planet.

This is Ecore's definition of **SUSTAINABILITY**

Can a floor make people's lives better in their environment, while simultaneously benefitting the natural environment?

Yes.

ecore | Built by Yes.



ecore™ | Athletic

ecoreathletic.com

Effective November 1, 2018

Price per square foot unless otherwise indicated

Lead time= time from when the ordered is entered into Epicor and ship date. Lead time is in business days.

SRL= Suggested roll lengths for this particular product.

MOQ= Minimum order quantity.

MSP= Minimum suggested price

EVERLAST					
8mm Basic Rolls					
	EL00, EL01, EL02, EL05	EL04, EL06, EL07, EL09, EL32B	EL45, EL46, EL47, EL97A	EL100B, EL101, EL102, EL103, EL104, EL106, EL107B, EL503	EL15A, EL43A, EL502
MSP	\$ 2.46	\$ 2.64	\$ 2.93	\$ 3.34	\$ 6.50
Lead Time	7-10 business days	7-10 business days	7-10 business days	7-10 business days	7-10 business days
SRL	25LF, 50LF	25LF, 50LF	25LF, 50LF	25LF, 50LF	25LF, 50LF
MOQ	25LF	25LF	25LF	25LF	25LF
NOTE:	Rolls are 48" W				
	The minimum order is 1 roll @ 25LF. Over the first 25LF, there is a minimum cut length of 15LF per roll.				
	Custom colors = 15-20 business day lead time from the time the order is entered into Epicor.				
	Custom colors require purchase of a full cylinder. Small Line Yield = 300 LF (+/- 6% manufacturing variance). Large Line Yield = 895 LF (+/- 6% manufacturing variance).				
8mm Quick Ship Rolls					
	EL00, EL01, EL02, EL05	EL04			EL43A
MSP	\$ 2.46	\$ 2.64			\$ 6.50
Lead Time	1-2 business days	1-2 business days			1-2 business days
SRL	25LF, 50LF	25LF, 50LF			25LF, 50LF
MOQ	25LF	25LF			25LF
NOTE:	Quick Ship product available in 25LF and 50LF rolls. Orders received by 9 a.m. EST will ship same business day.				
	Quick Ship orders requesting 15 or more rolls of a single color will not be considered quick ship and will ship within 5 business days.				
	Quick Ship orders requesting palletization will not be considered quick ship and will ship within 2 business days.				
	Stocked in the Corona, California and York, PA warehouses in 25LF and 50LF rolls.				
8mm Basic Interlocking Tiles 23"x23" (each tile 3.67 sqft)					
	EL00, EL01, EL02	EL05	EL04, EL06, EL07, EL09, EL32B	EL45, EL46, EL47, EL97A	EL100B, EL101, EL102, EL103, EL104, EL106, EL107B, EL503
MSP	\$ 3.49	\$ 3.49	\$ 3.67	\$ 4.43	\$ 4.70
Lead Time	3 business days (340 tile max); 7-10 business days (> 340 tiles)	10-15 business days	10-15 business days	10-15 business days	10-15 business days
MOQ	1 tile	50 tiles	50 tiles	50 tiles	50 tiles
Options	Center, border, and corner tiles	Center tiles only	Center tiles only	Center tiles only	Center tiles only
	EL15A, EL43A, EL502				
MSP	\$ 8.30				
Lead Time	10-15 business days				
MOQ	50 tiles				
Options	Center tiles only				
NOTE:	Tiles are custom cut and are not returnable.				

6mm Basic Rolls	
	EL00, EL01, EL02
MSP	\$ 2.33
Lead Time	7-10 business days
SRL	25LF, 50LF
MOQ	25LF
NOTE:	Rolls are 48" W
	The minimum order is 1 roll @ 25LF. Over the first 25LF, there is a minimum cut length of 15LF per roll.
	6mm can be produced as a custom product in any color. Full cylinder yields apply.

9mm Basic Rolls	
	EL00, EL01, EL02, EL05
MSP	\$ 3.35
Lead Time	7-10 business days
SRL	25LF, 50LF
MOQ	25LF
NOTE:	Rolls are 48" W
	The minimum order is 1 roll @ 25LF. Over the first 25LF, there is a minimum cut length of 15LF per roll.
	9mm can be produced as a custom product in any color. Full cylinder yields apply.

UltraTile® (each tile 4.00 sqft) - price per sqft					
	EL00	EL45, EL46	EL47, EL97A	EL100B, EL101, EL102, EL103, EL104, EL106, EL107B, EL503	EL502
MSP	\$ 7.54	\$ 8.03	\$ 8.03	\$ 8.60	\$ 10.37
Lead Time	Contact customer service	Contact customer service	Contact customer service	Contact customer service	Contact customer service
MOQ	1 tile	1 tile	1 tile	1 tile	1 tile
	EL15A, EL43A, EL500				
MSP	\$ 10.37				
Lead Time	Contact customer service				
MOQ	1 tile				

UltraTile® Quad Blok, Reducers & ADA Ramps (price per each)				
	Quad Blok Connector 12mm x 5" x 5" (price per each)	E Grip III Cartridge 10.1 oz. (price per each)	EL00, EL46 Reducers	EL00, EL46 ADA Ramp
MSP	\$ 2.47	\$ 6.64	\$ 31.26	\$ 36.81
Lead Time	1 business day	1 business day	5-20 business days	5-20 business days
MOQ	1 quad blok	1 cartridge	1 reducer	1 ramp
NOTE:	Material used for reducers pulled from UltraTile® skins.			
	Pricing is for reducers made in large cylinder.			
	Custom color reducers are not available.			
	1 Quad Blok per tile. Quad Bloks required for all installations and must be adhered with adhesive to the tile. This applies to full spread installations as well. Please see Technical Manual for more information.			
	E Grip III Cartridge 10.1 oz. covers 15 quad blocks (12mm).			

SmashTile 2.5" x 24" x 24" (each tile 4.00 sqft) - price per sqft				
	EL00	EL45, EL46, EL47, EL97A	EL100B, EL101, EL102, EL103, EL104, EL106, EL107B, EL503	EL15A, EL502, EL43A, EL500
MSP	\$ 18.14	\$ 25.22	\$ 25.84	\$ 28.50
Lead Time	20 business days	20 business days	20 business days	20 business days
MOQ	1 tile	1 tile	1 tile	1 tile

SmashTile Quad Blok, Reducers, & ADA Ramps				
	Quad Blok Connector 8" x 8" x 17mm (price per each)	E Grip III Cartridge 10.1 oz. (price per each)	Reducer 48" x 8" x 2-1/2" (price per each)	ADA Access Ramp Kit (price per kit)
MSP	\$ 4.70	\$ 6.64	\$ 54.70	\$ 400.76
Lead Time	1 business day	1 business day	20 business days	20 business days
MOQ	1 quad blok	1 cartridge	1 reducer	1 ramp kit
NOTE:	All SmashTile accessories are black softpave (no skin).			

	ADA Access kits includes (2) ADA Access Ramps, (1) 6" Transition Toe, and (1) Left/Right Side Reducer Pair.
	Pricing is for reducers made in large cylinder.
	Custom color reducers are not available.
	E Grip III Cartridge 10.1 oz. covers 10 quad blocks (17mm).

STACKED

Performance Motivate (2.5mm+5mm) Rolls

	ES46, ES45, ES47, ES97A	ES103, ES104, ES503	ES15A, ES502, ES43A, ES500	ES504, ES505, ES506, ES507	ES508, ES509, ES510, ES511
MSP	\$ 6.06	\$ 6.42	\$ 8.70	\$ 12.19	\$ 13.52
Lead Time	20 business days	20 business days	10 business days	20 business days	20 business days
SRL	50LF	50LF	50LF	50LF	50LF
MOQ	25LF	25LF	25LF	25LF	25LF
NOTE:	Rolls are 48" W				

Performance Rally (2.5mm+12mm) Rolls

	ES00	ES46, ES45, ES47, ES97A	ES103, ES104, ES503	ES15A, ES502, ES43A, ES500	ES504, ES505, ES506, ES507
MSP	\$ 7.08	\$ 7.52	\$ 7.87	\$ 10.02	\$ 13.34
Lead Time	10 business days	20 business days	20 business days	10 business days	20 business days
SRL	25LF	25LF	25LF	25LF	25LF
MOQ	25LF	25LF	25LF	25LF	25LF
	ES508, ES509, ES510, ES511				
MSP	\$ 14.80				
Lead Time	20 business days				
SRL	25LF				
MOQ	25LF				
NOTE:	Rolls are 48" W				

Performance Rally (2.5mm+12mm) 23" x 23" Interlocking Tiles (each tile 3.67 sqft)

	ES00	ES46, ES45, ES47, ES97A	ES103, ES104, ES503	ES15A, ES502, ES43A, ES500	ES504, ES505, ES506, ES507
MSP	\$ 8.18	\$ 8.72	\$ 9.23	\$ 11.68	\$ 15.51
Lead Time	10 business days	20 business days	20 business days	10 business days	20 business days
MOQ	50 tiles	50 tiles	50 tiles	50 tiles	50 tiles
	ES508, ES509, ES510, ES511				
MSP	\$ 17.20				
Lead Time	20 business days				
MOQ	50 tiles				

Performance Beast (2.5mm+8mm) Rolls

	ES00	ES46, ES45, ES47, ES97A	ES103, ES104, ES503	ES15A, ES502, ES43A, ES500	ES504, ES505, ES506, ES507
MSP	\$ 7.53	\$ 7.93	\$ 8.28	\$ 10.47	\$ 13.95
Lead Time	10 business days	20 business days	20 business days	10 business days	20 business days
SRL	25LF	25LF	25LF	25LF	25LF
MOQ	25LF	25LF	25LF	25LF	25LF
	ES508, ES509, ES510, ES511				
MSP	\$ 15.46				
Lead Time	20 business days				
SRL	25LF				
MOQ	25LF				
NOTE:	Rolls are 48" W				

Performance Monster (2.5mm+8mm/12mm) Rolls					
	ES00	ES46, ES45, ES47, ES97A	ES103, ES104, ES503	ES15A, ES502, ES43A, ES500	ES504, ES505, ES506, ES507
MSP	\$ 11.45	\$ 11.92	\$ 12.27	\$ 14.40	\$ 19.14
Lead Time	10 business days	20 business days	20 business days	10 business days	20 business days
SRL	25LF	25LF	25LF	25LF	25LF
MOQ	25LF	25LF	25LF	25LF	25LF
	ES508, ES509, ES510, ES511				
MSP	\$ 21.23				
Lead Time	20 business days				
SRL	25LF				
MOQ	25LF				
NOTE:	Rolls are 48" W				
	Kit, Performance 2.5mm +8mm will ship out of York with 12mm 4735.				
	E Grip III: 70-75 sq ft per gallon coverage over 4735.				

Speed & Agility Turf Rolls			
	3mm+5mm	3mm+12mm	
MSP	\$ 9.78	\$ 10.75	
Lead Time	3-20 business days	3-20 business days	
SRL	35LF	25LF	
MOQ	35LF	25LF	
NOTE:	Rolls are 72" W		

Speed & Agility Turf (3mm+12mm) 23" x 46" Interlocking Tiles (each tile 7.35 sqft)			
	Per square foot	Per tile (7.35 sqft)	Interlocking Turf Transition Black, 46"L x 12" W x 3/4"H (price per each)
MSP	\$ 11.37	\$ 83.55	\$ 150.17
Lead Time	3-20 business days	3-20 business days	1 business day
MOQ	25 tiles	25 tiles	1 reducer

Reducer- Straight Transition, Black, 48"L x 4"W x 3/4"H (price per each)		
	Black	
MSP	\$ 47.48	
Lead Time	1 business day	
MOQ	1 reducer	
NOTE:	Can be used with Speed & Agility 5mm, Speed & Agility 12mm, Performance Rally.	

ELEVATE

Bounce 2 (2mm+5mm) Rolls		
	Bounce 2	Weld Rod (per spool)
MSP	\$ 7.32	\$ 98.57
Lead Time	15 business days	1 business day
SRL	30LF	328LF
MOQ	30LF	1 spool
NOTE:	Rolls are 72" W	
	Weld Rods cover 328LF per spool.	

Roster (2mm + 5mm) 23"x 23" Interlocking Tiles (each tile 3.67 sqft)	
	Blue, Brown, Charcoal
MSP	\$ 7.65
Lead Time	20 business days
MOQ	1 tile

Aqueous (2mm) Rolls				
	4252, 4253	4258, 4257, 4255	Weld Rod (per spool)	Gerbert 2300 Adhesive
MSP	\$ 7.03	\$ 7.03	\$ 125.71	\$ 128.57
Lead Time	3 business days	5-7 weeks	1 business day	1 business day
SRL	65.71' (20m)	65.71' (20m)	328LF	N/A
MOQ	1 roll	1 roll	1 spool	1 pail
NOTE:	Width 6'7" (2m) x Length 65.71' (20m), 430.56 sqft (40 sqm) per roll.			
	4252 Amazon and 4253 Colorado are stocked in Lancaster, PA.			
	Available in full rolls only.			
	Requires Gerbert 2300 adhesive (215 sqft/pail).			
	Weld rods spool is 328 LF. The weld rod #'s match the flooring item (i.e. 4258-w).			

Frictional (2mm) Rolls			
	4860, 5500, 4770, 4760, 4805, 4815	Weld Rod (per spool)	Gerbert 2300 Adhesive
MSP	\$ 6.88	\$ 125.71	\$ 128.57
Lead Time	5-7 weeks	1 business day	1 business day
SRL	65.71' (20m)	328LF	N/A
MOQ	1 roll	1 spool	1 pail
NOTE:	Width 6'7" (2m) x Length 65.71' (20m), 430.56 sqft (40 sqm) per roll.		
	Available in full rolls only.		
	Requires Gerbert 2300 adhesive (215 sqft/pail).		
	Weld rods spool is 328 LF. The weld rod #'s match the flooring item (i.e. 4860-w).		

Spectator (2.5mm) Planks and Tiles			
	Wood	Texture	E-Grip Evolve Adhesive
MSP	\$ 3.37	\$ 3.37	\$ 121.43
Lead Time	3 business days	3 business days	1 business day
MOQ	1 carton	1 carton	1 pail
NOTE:	Wood visuals (except Dark Ash) are 6" x 36". 1 carton contains 24 planks (36 sf).		
	Dark Ash is 7" x 48". 1 carton contains 16 planks (37.28 sf).		
	Texture visuals are 18" x 18". 1 carton contains 16 tiles (36 sf).		
	Requires E-Grip Evolve adhesive (covers 600 sf).		
	Dark Ash is stocked in York and Corona. The remaining colors are stocked in York only.		

Training Ground with Nike Grind

TurfX 35mm		
	TurfX (solid color- 8380, 7750, 9999, 1000, 5300, 7400, 3000)	TurfX (custom)
MSP	\$ 9.25	Quote required
NOTE:	Must purchase the TurfX system (Turf + 10mm SmashPad).	
	Turf is 15' wide, Smash Pad is 4' wide.	
	Turf and SmashPad will ship separately, requiring two freight costs.	
	Turf minimum roll length is 10LF. Maximum roll length is 150LF.	
	SmashPad minimum roll length is 25LF.	
	Lead time for solid turf : 2 business days if material is in stock. If out of stock, lead time will need to be quoted.	
	Lead time for custom turf : Typically 20 business days. Lead time may vary depending on the quantity and complexity of the project(s). Lead times cannot be adjusted once the order is submitted due to production and space constraints. Once final artwork is provided, a ship date will be sent along with an order confirmation.	
	Lead times for SmashPad : 10 business days.	

ShockPad and Infill

Infill (price per pound)

	Green, Tan (1.0-3.5mm)	Ecore A-R (8-18 mesh)	
MSP	\$ 2.01	\$ 0.71	
Lead Time	20 business days	20 business days	

NOTE: Green & Tan is available in 55 pound bags or 2000 pound super sacks.

Ecore A-R is available in 2000 pound super sacks only.

BL41 (6010SP)

	8mm	10mm	12mm	
MSP	\$ 1.40	\$ 1.66	\$ 1.93	

NOTE: Rolls are 48" W.

8mm, 12mm = Custom Cut Lengths.

10mm = 210LF Standard Roll Length, upcharge for custom cut lengths.

Lead time is 10 business days for orders less than 40,000 sq ft.

Volume orders over 40,000 sq ft will require additional scheduling time and coordination to ensure timely pick-up and

BL40 (4735)

	12mm	
MSP	\$ 2.04	

NOTE: Rolls are 48" W.

Custom Cut Lengths.

Lead time is 10 business days for orders less than 40,000 sq ft.

Volume orders over 40,000 sq ft will require additional scheduling time and coordination to ensure timely pick-up and

BL46 (6015H)

	3mm x 59in x82LF Roll	5mm x 59in x82LF Roll	7mm x 59in x82LF Roll	9mm x 59in x82LF Roll	
MSP	\$ 0.70	\$ 1.03	\$ 1.40	\$ 1.74	

NOTE: Rolls are 59" W.

Lead time is 7 business days for orders less than 40,000 sq ft.

Volume orders over 40,000 sq ft will require additional scheduling time and coordination to ensure timely pick-up and

Accessories and Notes

Mats (price per mat)

	Logo Mat w/ Edging 4'x6'	Complex Mat w/ Edging 4'x6'	Plain Mat w/ Edging 4'x6'	
MSP	\$ 914.80	\$ 1,052.24	\$ 653.90	
	Logo Mat w/ Edging 6'x10'	Complex Mat w/ Edging 6'x10'	Plain Mat w/ Edging 6'x10'	
MSP	\$ 2,092.46	\$ 2,406.54	\$ 1,441.11	

NOTE: Freight charges will apply. No pickups, they must be shipped and freight charges will be provided along with proofs.

Base colors: Charcoal, Midnight, Gray, and Zinc.

Accent colors: Black, Purple, Azure, Royal Blue, Verde, Kelly Green, Orange, Gold, Yellow, Bright Red, Solid Crimson, Red, Natural, and White.

Complex is any mat with over three inlay colors. Logo mats with high level of detail and low colors could also be considered complex.

Level of detail will be evaluated upon reviewing the art files and a decision will be made whether it is a standard request or complex request.

Lead-times can vary anywhere from 10-21 business days (depending on the quantity and complexity of the mat). Once final artwork is provided, a ship date will be sent along with an order confirmation.

Accessories				
	2-Gallon E Grip III	4-Gallon E Grip III	E Grip III Cartridge 10.1 oz.	4- Gallon E Grip Evolve
MSP:	\$121.43	\$207.14	\$6.64	\$121.43
NOTE:	Covers 190 sqft	Covers 380 sqft	Covers 12 sqft	Covers 600 sqft
	E-Cleaner (1-gal)	E-Finish (1-gal)	E-Stripper (1-gal)	
MSP:	\$36.36	\$57.56	\$72.13	
NOTE:	\$1,492.56/pallet qty only	\$2,741.01/pallet qty only	\$3,072.60/pallet qty only	
	Palletizing Orders	Heat-Treated Pallets	Packaging Change Fee	Storage
	\$13.00/pallet	\$18.40/pallet	\$100 plus labor hours and pallet charges	\$125/week
NOTE:	Packaging change fee = loose rolls to pallet, request shrink-wrap, repackaging after the order is entered. Change requests will be quoted by the account manager when requested.			shipment delay after 48 hrs

PLEASE NOTE THE FOLLOWING:

- *For **suggested/standard roll lengths**: manufacturer reserves the right, at its sole discretion, to ship standard length rolls that are $\pm 10LF$ AND/OR spliced for no more than 10% of the order. For example, on an order 30 standard rolls, no more than 3 rolls will be $\pm 10LF$.
- *For **custom cut lengths, non standard offering, and custom colors**: manufacturer reserves the right, at its sole discretion, to ship 0-10% overage on your order.
- *For any tiles or lamination jobs that are under the minimum order requirements, a setup fee (\$250) is assessed.
- *Please contact Jeff Ressler for custom material pricing.
- *Custom products (colors, cuts, coating) are non-returnable
- *Adhesive is non-returnable.
- *Any customers returning product will be assessed a 25% restocking fee. Credit will only be given for items returned in sellable quality.
- *Any special packaging requests need to be outlined on the purchase order.
- *No changes to shipping location or carrier accepted 2 business days prior to shipment.
- *After two day grace period, delayed shipments will be assessed a \$125 storage fee. Customer will be charged on the 3rd business day the initial \$125
- *No changes to the orders can be made four days prior to the scheduled ship date.
- *If customer states "ship ASAP" the order is considered final and no changes to the product can be accepted once order confirmation is sent.
- *Orders that do not have all necessary information, cannot be processed until complete information is provided.
- *Lead times for pay in advance customers will begin upon receipt of payment.
- *Heat treated pallets are required for all international shipments.
- *Rolled rubber products are shipped as loose rolls unless specifically requested. Please note pallet charges above.
- *Splices: manufacturer reserves the right, at its sole discretion, to ship standard length rolls that are spliced for no more than 10% of the order. For example, on an order 30 standard rolls, no more than 3 rolls will be spliced.